

CUTTING PLOTTER

CG-60SR^{III}

CG-100SR^{III}

CG-130SR^{III}

OPERATION MANUAL

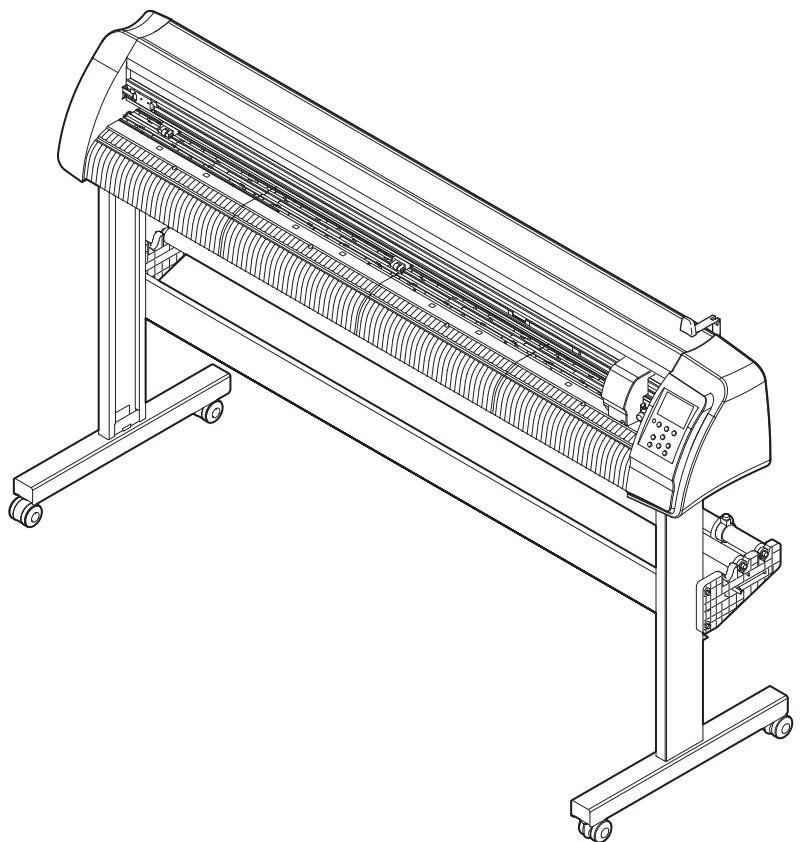

You can also download the latest manual from our website.

MIMAKI ENGINEERING CO., LTD.

URL: <http://eng.mimaki.co.jp/>

D202472-16

OPERATION MANUAL

TABLE OF CONTENTS

CAUTION	v
CAUTION	v
Requests	v
FCC Statement (USA)	v
Interference to televisions and radios	v
Foreword	vi
About media	vi
On This Operation manual	vi
Features	vii
Safety Precautions	viii
Pictorial signs	viii
Safety Labels	x
How to Read This Operation Manual	xi

CHAPTER 1 Before Use

Where to install this machine	1-2
Configuration and function	1-3
The Front	1-3
The Rear	1-4
Operation Panel	1-5
Tray	1-6
Carriage	1-6
Pinch rollers and grit rollers	1-7
Clamp	1-8
Sheet sensor	1-8
Connecting the cables	1-9
USB Cable Connection	1-9
RS-232C Cable Connection	1-9
LAN Cable connection	1-9
Connecting the power cable	1-10
Menu mode	1-11

CHAPTER 2 Basic Operations

Installing a tool	2-3
Using a cutter	2-3
How to Install a Ballpoint Pen	2-6
Turning the power on	2-8
Setting the tool conditions	2-9
Kinds of the Tool Conditions	2-9
Select the tool condition	2-10
Set the Tool Conditions	2-10

Setting a sheet	2-13
Setting a leaf sheet (cut sheet)	2-16
How to Place the Roll Sheet (CG-60SRIII)	2-17
How to Place the Roll Sheet (CG-100SRIII/CG-130SRIII)	2-19
Test cutting (plotting)	2-22
Cutting (plotting)	2-23
Setting the origin	2-23
Start cutting (plotting)	2-24
Cut off the Sheet (Manual Cutting)	2-25
Turning the power off	2-26

CHAPTER 3 Useful Function

Functions in the Jog Mode	3-2
Setting the origin	3-2
Two-point axis alignment	3-3
Cutting area	3-4
Digitization operation	3-5
Set the distance compensation	3-6
Perform Multiple Cuttings	3-9
Cut Out Data with Registration Mark	3-11
The Flow of Cutting out the Registered Data	3-11
Enter the registration mark detection mode	3-11
Precautions in inputting data with registration marks ..	3-12
Set for Detecting the Registration Marks	3-16
Method of detecting registration marks	3-21
Confirm the following when failed in cutting correctly. .	3-29
Expand the cutting (plotting) area	3-35
Set the EXPANDS function to ON.	3-35
Switch the cutting (plotting) direction	3-37
The Setting of ROTATION.	3-37
Perform DIVISION cut	3-39
Set the Y direction (width direction) DIVISION cut ..	3-39
Set the X direction (feeding direction) DIVISION cut ..	3-41
Cut Data via DIVISION CUT.	3-43
Change the cutting (plotting) order	3-44
Set SORTING	3-44
Sorting sequence	3-46

Other Useful Functions	3-47
Feed the paper	3-47
HOLD	3-48
DATA CLEAR - Discontinue Plotting -	3-48
Perform SAMPLE CUT to Find out the Cause of Cutting Error.	3-49
Output the Setting List	3-50
Output the received data by the ASCII code [ASCII DUMP]	3-51
Set the configurations with a computer	3-52
Make the media without uncut area	3-54
Select the number of pinch roller to use	3-56
Setting the FEED OFFSET	3-57
Setting the FEED SPEED	3-58
Setting the PRE FEED	3-59
Set the network	3-61
Setting event mail function	3-63
Miscellaneous Settings	3-74
Switch the display language	3-74
Switch the User	3-75
Other Convenient Settings	3-76
Copy the set value from the other user setting.	3-84
Reset the setting values to the initial state.	3-85

CHAPTER 4 In Case of Trouble

Before taking a phenomenon as a trouble	4-2
Troubles for which error messages are given on the LCD	4-4
Error message	4-4
Status message	4-7

CHAPTER 5 Appendix

Specifications of the main unit	5-2
Repeatability condition	5-3
Cutter blade	5-4
Replacing the cutter	5-4
Adjusting the cutter blade	5-4
Replacing the cutter other than supplied one	5-5
Adjusting blade edge of cutter other than supplied one	5-5
Note slip	5-6

Function Flowchart	5-7
Functions invoked with the specific keys	5-7
Functions invoked with the jog mode (jog keys)	5-9
Functions	5-10

CAUTION

CAUTION

DISCLAIMER OF WARRANTY : THIS LIMITED WARRANTY OF MIMAKI SHALL BE THE SOLE AND EXCLUSIVE WARRANTY AND IS IN LIEU OF ALL OTHER WARRANTIES, EXPRESS OR IMPLIED, INCLUDING, BUT NOT LIMITED TO, ANY IMPLIED WARRANTY OF MERCHANTABILITY OR FITNESS, AND MIMAKI NEITHER ASSUMES NOR AUTHORIZES DEALER TO ASSUME FOR IT ANY OTHER OBLIGATION OR LIABILITY OR MAKE ANY OTHER WARRANTY OR MAKE ANY OTHER WARRANTY IN CONNECTION WITH ANY PRODUCT WITHOUT MIMAKI'S PRIOR WRITTEN CONSENT. IN NO EVENT SHALL MIMAKI BE LIABLE FOR SPECIAL, INCIDENTAL OR CONSEQUENTIAL DAMAGES OR FOR LOSS OF PROFITS OF DEALER OR CUSTOMERS OF ANY PRODUCT.

Requests

- This Operation manual has been carefully prepared for your easy understanding. However, please do not hesitate to contact a distributor in your district or our office if you have any inquiry.
- Description contained in this Operation manual are subject to change without notice for improvement.
- Generally, names and designations referred to in this Operation manual are trade marks or registered trade marks of the manufacturers or suppliers.

FCC Statement (USA)

This equipment has been tested and found to comply with the limits for a Class A digital device, pursuant to Part 15 of the FCC Rules. These limits are designed to provide reasonable protection against harmful interference when the equipment is operated in a commercial environment. This equipment generates, uses and can radiate radio frequency energy and, if not installed and used in accordance with the Operation manual, may cause harmful interference to radio communications. Operation of this equipment in a residential area is likely to cause harmful interference in which case the user will be required to correct the interference at his own expense.



- In the case where MIMAKI-recommended cable is not used for connection of this device, limits provided by FCC rules can be exceeded. To prevent this, use of MIMAKI-recommended cable is essential for the connection of this plotter.

Interference to televisions and radios

The product described in this manual generates high frequency when operating.

The product can interfere with radios and televisions if set up or commissioned under improper conditions. The product is not guaranteed against any damage to specific-purpose radio and televisions.

The product's interference with your radio or television will be checked by turning on/off the power switch of the product.

In the event that the product is the cause of interference, try to eliminate it by taking one of the following corrective measures or taking some of them in combination.

- Change the orientation of the antenna of the television set or radio to find a position without reception difficulty.
- Separate the television set or radio from this product.
- Plug the power cord of this product into an outlet which is isolated from power circuits connected to the television set or radio.

About media

Please follow the local regulations to dispose of roll sheets or other media.

Congratulations on your purchase of a CG-SR11 series cutting plotter.

CG-SR11 series cutting plotter is a highly functional cutting plotter with the high-speed registration mark detection.

Read this Operation manual carefully and make the most effective use of your plotter.

On This Operation manual

- This Operation manual describes the operation and maintenance of CG-SR11 series cutting plotter (hereinafter referred to as the plotter).
- Please read and fully understand this Operation manual before putting the machine into service. It is also necessary to keep this operation manual on hand.
- Make arrangements to deliver this Operation manual to the person in charge of the operation of this plotter.
- This Operation manual has been carefully prepared for your easy understanding. However, please do not hesitate to contact a distributor in your district or our office if you have any inquiry.
- Description contained in this Operation manual are subject to change without notice for improvement.
- In the case where this Operation manual should be illegible due to destruction or lost by fire or breakage, purchase another copy of the Operation manual from our office.
- You can also download the latest operation manual from our website.

Features

The features of the plotter are described below. Together with the method of operation of the plotter explained in this manual, they help you understand how to use the machine properly.

Mark Sensor

The high accuracy mark-detection sensor enables the plotter to read the mark plotted on sheets automatically, compensate distances, set the plotting origin and correct paper skew.

Roll Sheet Stopper

The roll sheet stopper helps the plotter feed a roll paper without sagging. In addition, the improved sheet let-off surface reduces the jam of a roll sheet. Thus the troubles are minimized.

Two Clamp Pressure Modes Changeover Mechanism

The sheet clamp system incorporate two clamp pressure modes changeover mechanism to widen the available sheet size range.

Strong pressure mode substantially increases the clamp pressure to prevent a long sheet from slipping.

The moderate pressure mode prevents the media from getting scratched by the grit roller during plot operation.

Front Loading

You can mount the roll-placing table in the front side to cut the front-loaded roll sheet.

Plug-in Cutting Software (FineCut) Attached











The plug-in software FineCut, enables easy and fine cutting of the characters or illustrations edited on the Illustrator or CorelDRAW.

Safety Precautions

Pictorial signs





Pictorial signs are used in this Operation manual for safe operation and for prevention of damage to the plotter. Pictorial signs and their meanings are given below. Read and fully understand before reading the text.

Examples of symbols

	Failure to observe the instructions given with this symbol can result in death or serious injuries to personnel. Be sure to read and observe the instructions for proper operation.
	Failure to observe the instructions given with this symbol can result in injuries to personnel or damage to property.
	This symbol indicates that the information is helpful in proper operation of the plotter..
	This symbol indicates that it is important to know of the information on proper operation of the plotter. Use this information for your operation.
	Indicates the reference page for related contents.
	The symbol “  ” indicates that the instructions must be observed as strictly as the CAUTION instructions (including DANGER and WARNING instructions). A sign representing a precaution (the sign shown at left warns of hazardous voltage) is shown in the triangle.
	The symbol “  ” indicates that the action shown is prohibited. A sign representing a prohibited action (the sign shown at left prohibits disassembly) is shown in or around the circle.
	The symbol “  ” indicates that the action shown must be taken without fail or the instructions must be observed without fail. A sign representing a particular instruction (the sign shown at left instructs to unplug the cable from the wall outlet) is shown in the circle.











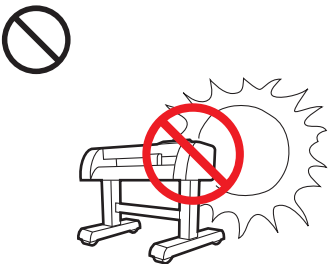
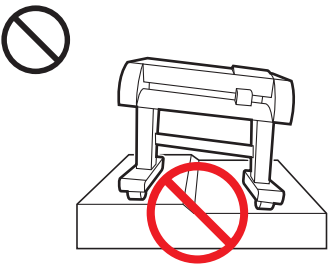

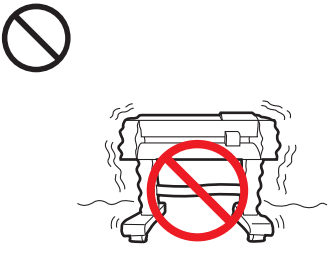
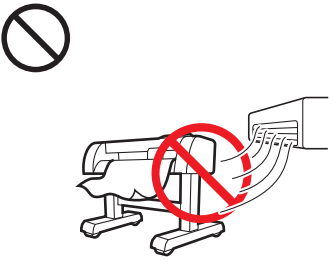
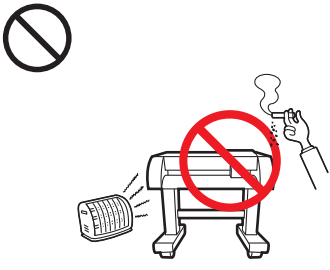
WARNING

Do not disassemble or remodel the plotter.	Handling of the power cable
 <ul style="list-style-type: none"> • Never disassemble or remodel the plotter. Disassembly or remodeling can result in an electric shock or breakdown of the machine. 	 <ul style="list-style-type: none"> • Use the supplied power cable. Take care not to damage, break or work upon the power cable. If a heavy material is placed on the power cable, or if it is heated or pulled, the power cable can break, thus resulting in fire or electric shocks.
Avoid locating the plotter in a damp environment.	In case abnormal event occurs.
 <ul style="list-style-type: none"> • Do not use the plotter in a damp place. Do not splash water onto the machine. Use in such an environment can give rise to fire, electric shocks or breakdown of the plotter. 	 <ul style="list-style-type: none"> • Use of the plotter under an abnormal condition where the device produces smoke or strange smell can result in fire or electric shocks. If such an abnormality is found, be sure to turn off the power switch immediately and unplug the cable from the wall outlet. Check first that the plotter no longer produces smoke, and contact your distributor for repair. • Never repair your plotter by yourself since it is very dangerous for you to do so.



CAUTION

A place exposed to direct sunlight	On an inclined surface	A place where temperature or humidity varies significantly
		 <ul style="list-style-type: none"> • Use the plotter under the following environmental conditions: • Operating environment: 5 to 35°C 35 to 75% (Rh)
A place that vibrates	A place exposed to direct air flow from an air conditioner or the like.	Around a place where fire is used
		

 CAUTION	
<p>Be careful with the movable parts</p> <ul style="list-style-type: none">  Do not touch the rolling grit roller; otherwise, you may hurt your fingers or tear off your finger nails.  Keep your head and hands away from any moving parts during cutting (plotting) operation; otherwise, you may get your hair caught in the machine or get injuries.  Wear proper clothes. (Do not wear loose-fit clothes or accessories). Bind a long hair. 	<p>Caution with cutters</p> <ul style="list-style-type: none">  Do not touch the cutter blade, which is very sharp. Do not shake or swing the cutter holder; otherwise, the blade may come off.
<p>Sheets</p> <ul style="list-style-type: none">  Straighten the sheet of media, if significantly curled, before using it for printing. Heavily curled sheet affects the cutting (plotting) result. 	<p>Connection of power supply cable</p> <ul style="list-style-type: none">  Be sure to connect the ground wire. Using without the ground wire causes the damage of this device and electric shock that may be very dangerous. Regarding the use of two polar plug outlet, you must connect the auxiliary ground adapter to the plug of power cable. Earth the green wire (ground wire) of the ground adapter. If you cannot, consult with an electrician.

Safety Labels

A safety label is stuck on the machine. The label informs the user of possible risks associated with the machine.

Be sure to understand the correct meaning of the safety label to avoid danger.

If the safety label is illegible due to stains or has come off, purchase a new one from your local distributor or our office. (Reorder: No.M904451, Safety label)

Depending on the manufacturing time, the label differs. When reordering the label, please ask for M904451 as a order number.

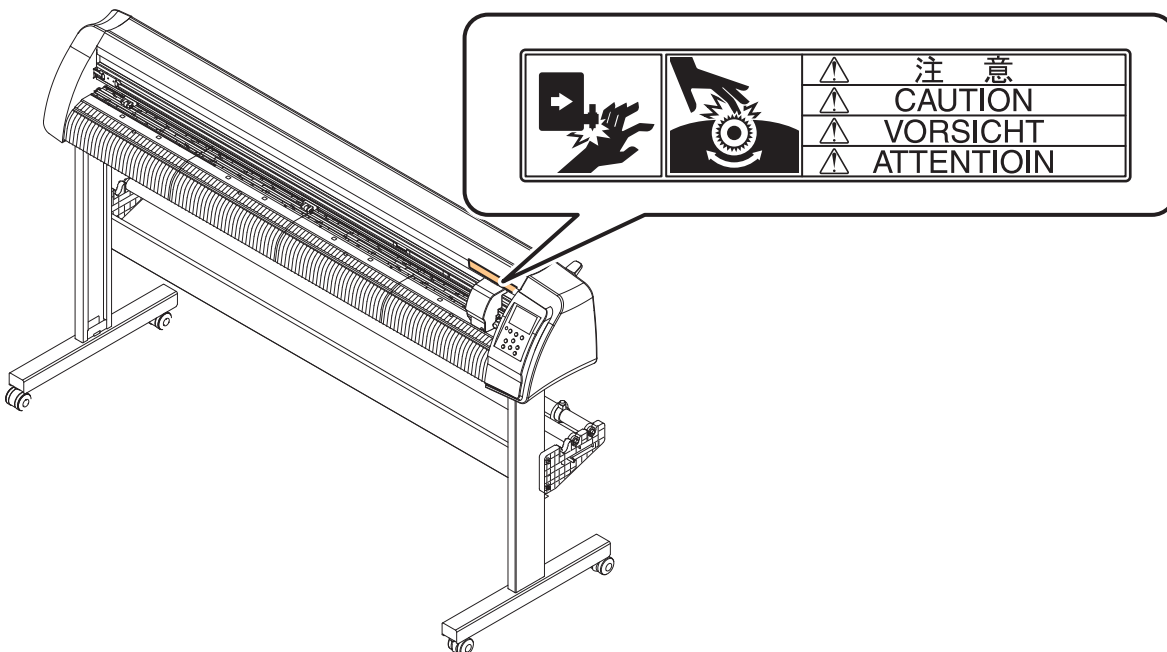

How to Read This Operation Manual

This manual provides the explanation about the displayed characters and used keys on the “Display Panel” in addition to the operation procedures.
Proceed operations confirming them while using.

Perform Multiple Cuttings

This function performs cutting (plotting) for the received data on two or more sheets. (Maximum 99

This explains the outline of functions.

- You can perform multiple cuttings by specifying data saved in the receiving buffer of this device.
- The receiving buffer can save only one data.
- When a new data is received, the data that has been saved is overwritten by it. (You cannot perform multiple cuttings by specifying the data that was received before.)

- 1** Press the **[FUNCTION]** key in the local mode.
- 2** Press the jog key **[▲]** or **[▼]** to select **[No.COPIES]**.
- 3** Press the **[ENTER/HOLD]** key.
- 4** Press the jog key **[▲]** or **[▼]** to select the number of cutting (1 to 999), and press the **[ENTER/HOLD]** key.
- 5** Press the jog key **[▲]** or **[▼]** to select the interval of figures to be cut (0 to 30mm), and press the **[ENTER/HOLD]** key.

<FUNCTION>
SQUARE CUT <ENT>

FUNC | TOOL | REMOTE

<FUNCTION>
No.COPIES <ENT>

FUNC | TOOL | REMOTE

<No.COPIES>
No.COPIES : 1

FUNC | TOOL | REMOTE

<No.COPIES>
No.COPIES :10

FUNC | TOOL | REMOTE

↓

<No.COPIES>
INTERVAL :1mm

FUNC | TOOL | REMOTE

<No.COPIES>
INTERVAL :10mm

FUNC | TOOL | REMOTE

↓

<FUNCTION>
No.COPIES <ENT>

FUNC | TOOL | REMOTE

3-9

3

Useful Function

These are what we want you to know in advance.

These are the number of operation procedures.

This shows the display panel.

enclose shows the buttons in a sentence.

CHAPTER 1

Before Use



This chapter describes the parts name and setting procedures before use.

- Where to install this machine 1-2**
- Configuration and function 1-3**
 - The Front 1-3
 - The Rear 1-4
 - Operation Panel 1-5
 - Tray 1-6
 - Carriage 1-6
 - Pinch rollers and grit rollers 1-7
 - Clamp 1-8
 - Sheet sensor 1-8
- Connecting the cables 1-9**
 - USB Cable Connection 1-9
 - RS-232C Cable Connection 1-9
 - LAN Cable connection 1-9
 - Connecting the power cable 1-10
- Menu mode 1-11**

Where to install this machine

Secure a suitable installation space before assembling this machine.

The place of installation must have enough space for not only this machine itself but also for printing operation.

Model	Width	Depth	Height	Gross weight
CG-60SRIII	1030 mm	287 mm	335 mm	24 kg
CG-100SRIII	1530 mm	580 mm	1150 mm	41 kg
CG-130SRIII	1830 mm	580 mm	1150 mm	46 kg

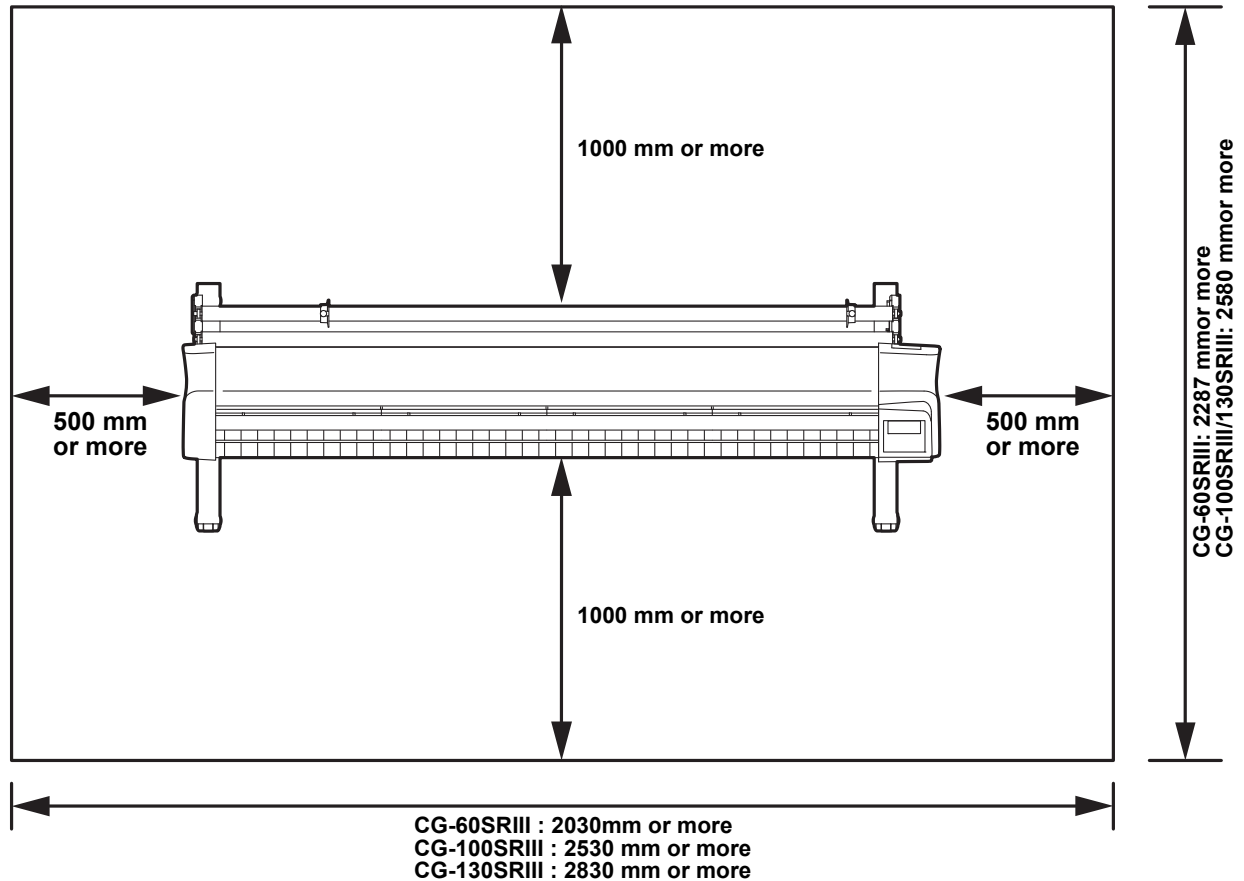

Configuration and function

The Front

Pinch roller

The pinch rollers feed out the sheet while pressing it against the grit rollers. (☞ P.1-7)

Grit roller

The grit rollers operate in combination with the pinch rollers to feed the sheet. (☞ P.1-7)

Pen line

The plotter performs cutting or plotting on the pen line.

Platen

The sheet of media moves along the platen.

Cut slot

The slot is used for cutting the sheet manually. (☞ P.2-25)

Carriage

The carriage carries the pen and moves it up and down. (☞ P.1-6)

Sheet sensor

This sensor detects the presence of the sheet and sheet length. (☞ P.1-8)

Pinch roller guide mark

This marks indicate the locations at which the pinch roller are to be set.

Clamp lever

Pushing a lever down lowers a pinch roller and retains the sheet.

Operation panel

This panel operates this machine and sets functions. (☞ P.1-5)

Roll stopper (CG-100/130SRIII)

When setting a sheet, prevents the roll sheet from rotating. (☞ P.2-20)

Power switch

The switch turns on/off the power. (☞ P.2-8, 2-26)

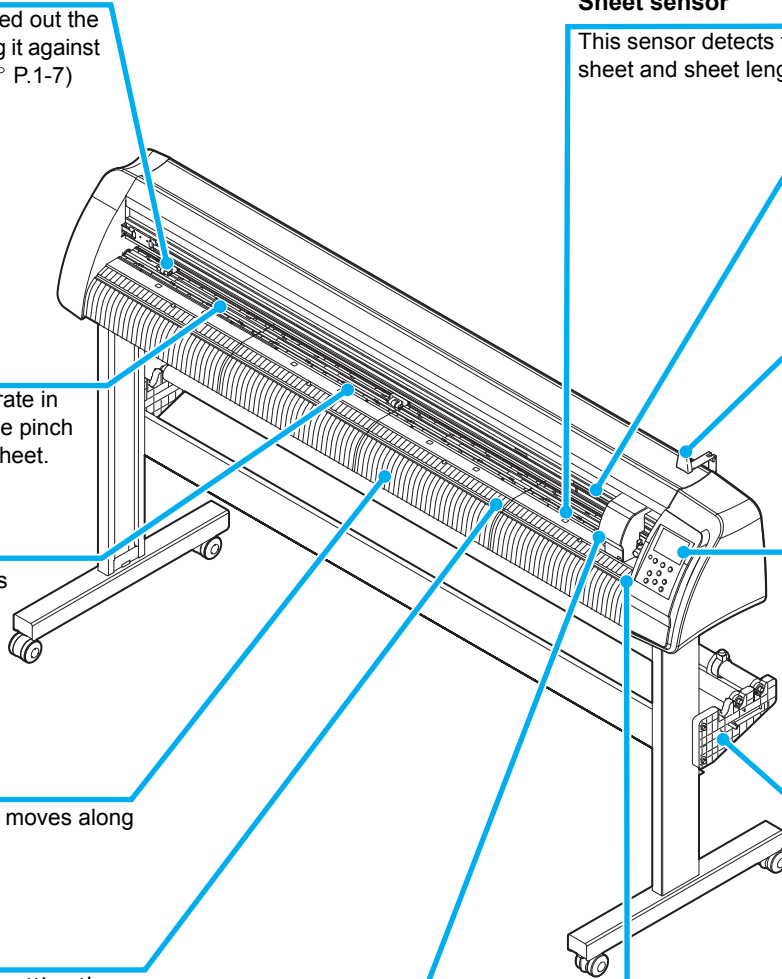

1

Before Use

The Rear

Clamp pressure lever

This lever adjusts the force by which the clamp is held. (P.1-8)

Sheet sensor

This sensor detects the presence of the sheet and sheet length. (P.1-8)

Tray

Small tools, such as a retractable knife and other cutters, can be placed on.

Roll stay

Roll stays support the roll bars. (P.2-19)

Roll bar

A roll sheet is placed on the two roll bars. (P.2-19)

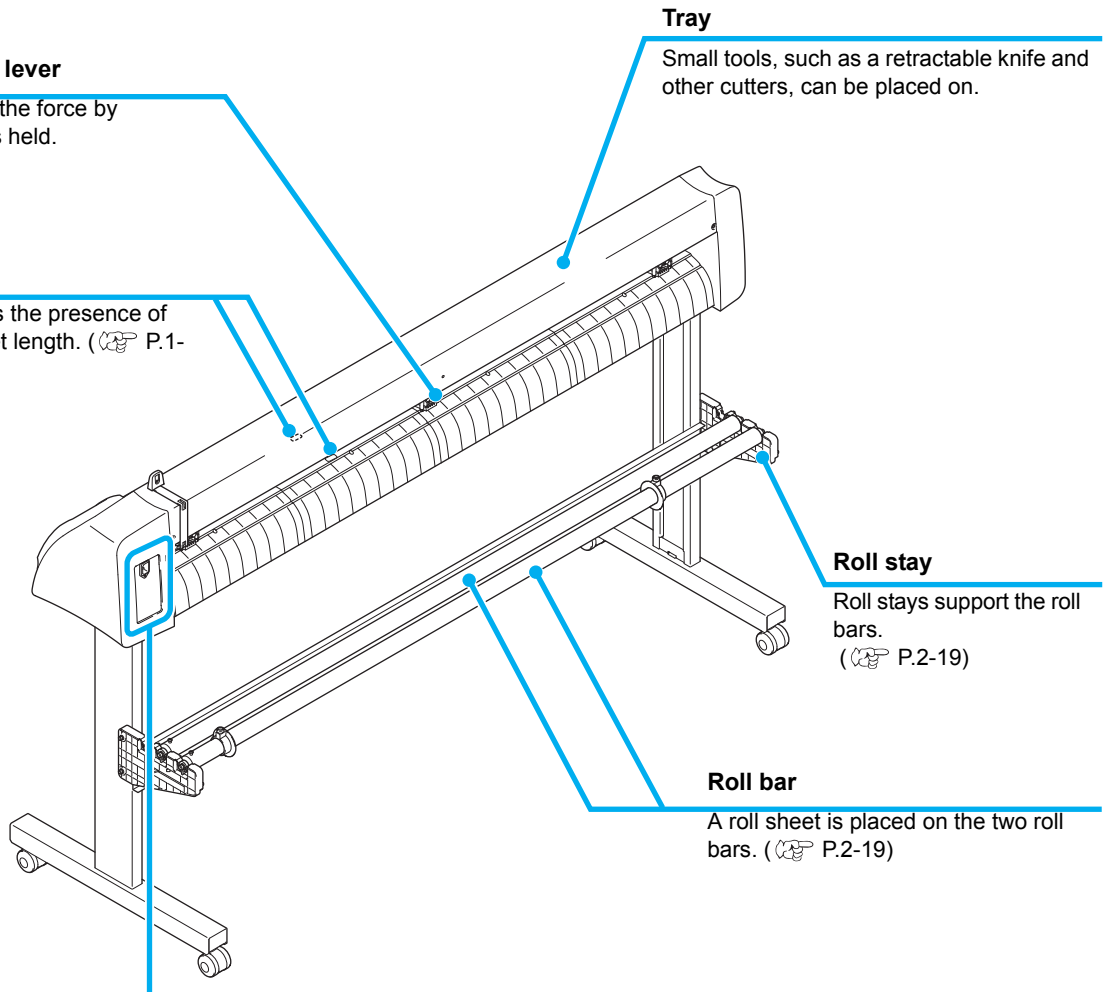

RS-232C interface connector

The RS-232C interface connector. (P.1-9)

USB interface connector

The USB interface connector. (P.1-9)

LAN connector

The LAN connector. Please use when you use event mail function.

AC inlet

The power cable is connected to the AC inlet. (P.1-10)

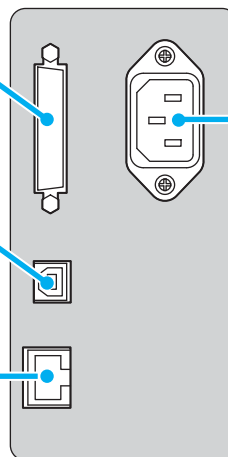

Operation Panel

Display panel

The display panel indicates tool conditions such as speed, pressure and offset, tool coordinates, functions and error messages.

Important!

Press the keys with the fingers.

Pressing with a sharp blade or a pointed thing may break the key.

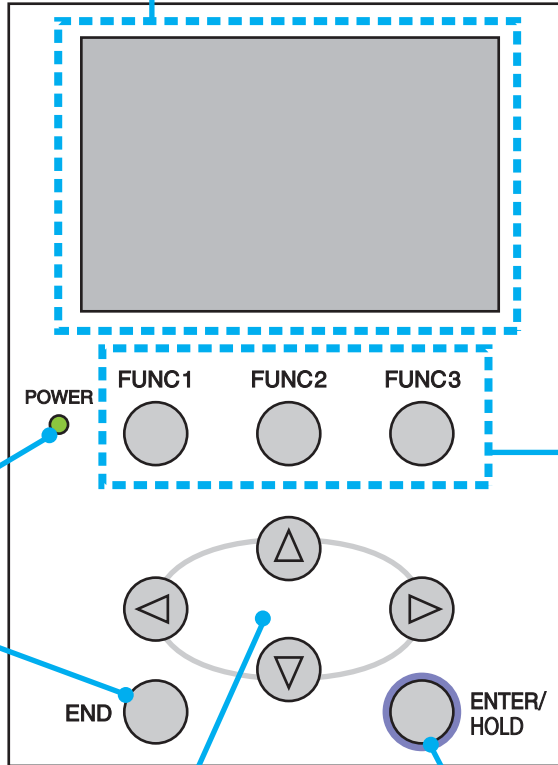

POWER lamp

This lamp lights up when the power to the plotter is turned on.

END key

This key cancels the last input value or returns the setting menu to the immediate higher level in the hierarchy. Use the key to detect only the sheet width.

JOG Key

Each of these arrow keys shifts the carriage or sheet in the direction of the arrow or changes settings. (P.1-5)

FUNCTION key

Use this key to enter function setting mode. The functions of FUNC1 to FUNC3 are displayed at the bottom of the display panel.

ENTER/HOLD key

This key registers the operation or the settings. Use the key to correct the drifting of the sheet during cutting (plotting) operation. (P.3-48)

Jog keys

The arrow keys are used as described in the table below.

	Before detection of a sheet	After detection of a sheet	When selecting a function	When selecting a setting value
	Detects the width and the front edge of the sheet.	Shifts the carriage to the left.	-	-
	Detects the width and length of the sheet.	Shifts the carriage to the right.	-	-
	Detects the width and the rear edge of the sheet.	Move the sheet toward the rear of the plotter.	Restores the previous function.	Selects the previous value.
	Detects the width and length of the sheet.	Move the sheet toward the front of the plotter.	Selects the next function.	Selects the next value.

In this manual, the sheets of media other than roll sheets are referred to as leaf sheets or cut sheets.

Tray

Small tools, such as a retractable knife, may be placed on the tray.

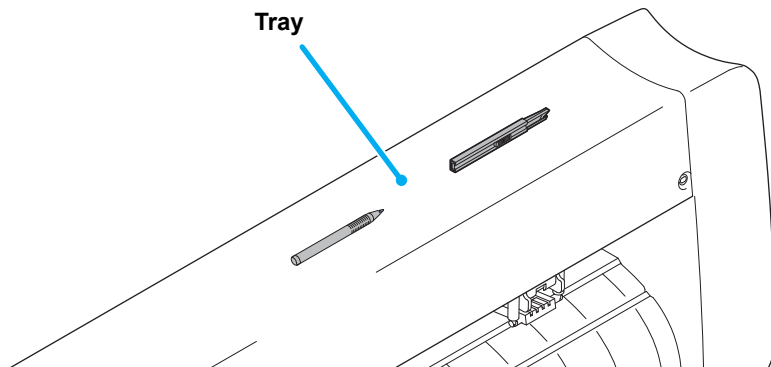

Important!

- However, keep a retractable knife or any other cutter out of reach of children since it can be dangerous.
- Do not put any heavy object on the tray; otherwise, the cover may deform and come in contact with the carriage.

Carriage

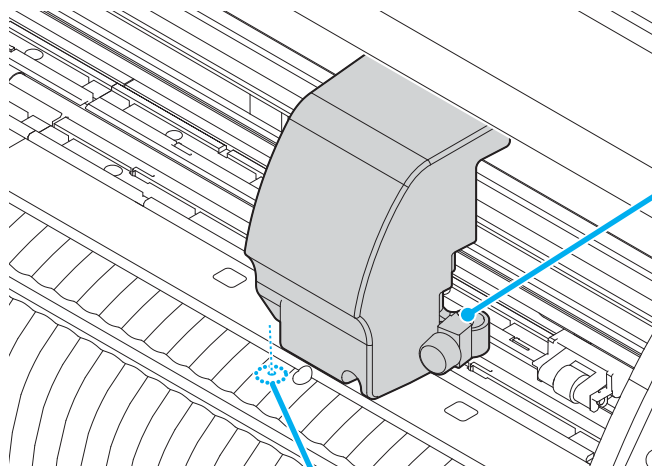

Tool holder

Fix a pen-type cutter for cutting and a rollerball for plotting.

Light Pointer

The light pointer lights up in red during positioning for the registration mark detection.

The light pointer also lights up before detecting the sheet and goes out upon detection of the sheet.

However, the light pointer goes out automatically when five minutes have passed without no sheet detected. (☞ P.3-21)

Pinch rollers and grit rollers

Align the pinch roller to the width of the sheet to be set, and move it to an appropriate position of the grit roller. The movement range of the pinch roller is as shown below. Move the pinch roller guessing the pinch roller guide marks as the measure.

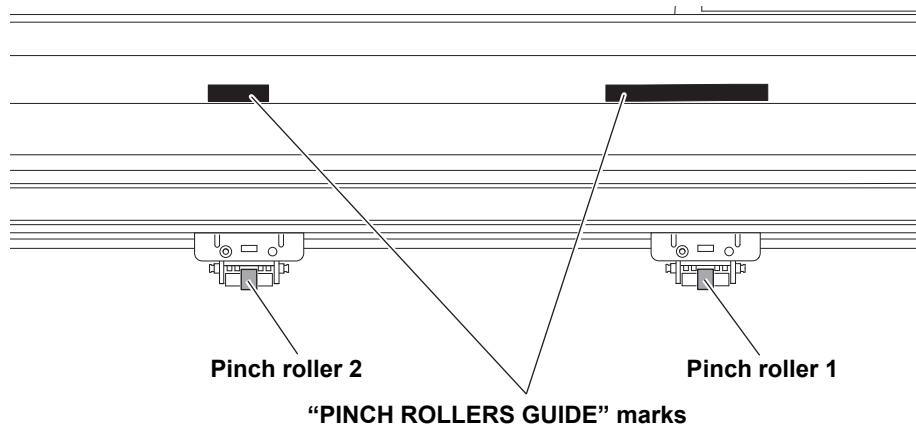

- Keep away from the rotating grit rollers. If you touch the rotating grit rollers, you can injure your fingers with them or your can get your fingers caught between the rotating grit rollers and the platen.



- Be sure to raise the pinch rollers whenever the machine is not operated. Otherwise, the pinch roller may be deformed.
- Never set the pinch rollers in any positions deviated or separated from the grit rollers. In case the pinch rollers are not set properly, they may cause an error and the sheet detection cannot be performed correctly.

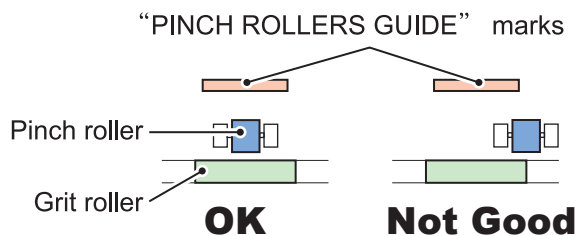

Clamp

The clamp pressure can be changed in two levels using the clamp pressure lever. Select the higher or lower level of the clamp pressure that matches the sheet to be used.

High mode

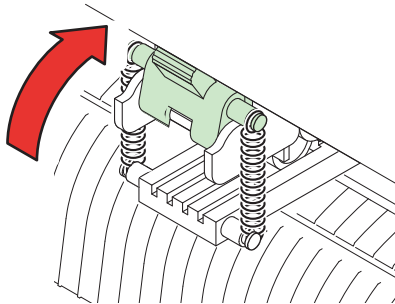

Raise the clamp pressure lever.

Low mode

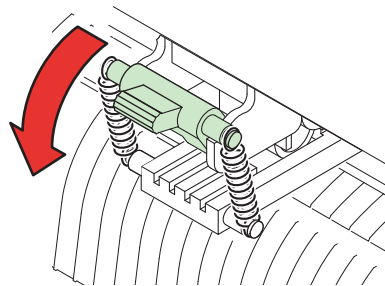

Lower the clamp pressure lever.

Important!

- Be sure to set the clamps of the left and right to the same mode for use. If the clamps' modes are different, it may cause the sheet misalignment.

Important!

- After setting the position of the pinch roller, set the clamp pressure.

Clamp pressure	Application
High mode	For cutting a PVC sheet. When a heavy-weight sheet of media (70 kg or 81g/m ² or more) is used.
Low mode	When the impression of the pinch rollers on the sheet of media are to be minimized. Important! • The sheet may drift depending on the sheet type, feed length, or the sheet width.

Sheet sensor

The sheet sensor detects the presence of the sheet and the sheet length. There is one for each position before and after the platen.

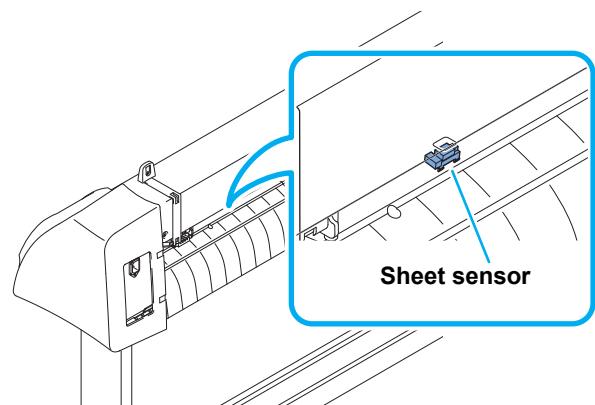
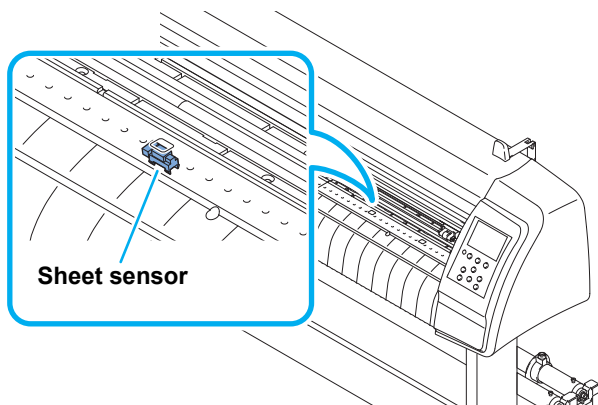

Connecting the cables

This plotter uses the USB, LAN and RS232C connector for connection to the host computer.



- Connect or disconnect the connectors carefully. Applying undue force to a connector may damage the connector.

USB Cable Connection

When connecting the USB cable, you must observe the followings.



- Do not plug in or unplug any cable during data transferring.
- Follow the instructions on the LCD if the wizard is displayed when connecting the USB cable.

Connecting USB driver

As for USB driver connection, refer to “USB Driver Installation Guide” in the FineCut supplied with this machine.

- (1) Set the supplied CD for FineCut into the disk drive.
- (2) Click [CD-ROM Contents] on the menu.
- (3) Open [InstallGuid(en).pdf] for the plotter used in [Mimaki Device Driver] folder.

RS-232C Cable Connection

When you want to connect the RS-232C cable, you must observe the following notabilia.



- When connecting the cables, turn off first the power to the device and that to the host computer which the power cable is to be connected.
- Do not plug in or unplug any cable during data transferring.

LAN Cable connection

When connecting LAN cable, be sure to follow the note below:



- Surely insert LAN cable until clicking noise sounds.
- Do not plug in or unplug any cable during data transferring.

Connecting the power cable

After connecting the interface cable, you must connect the power cable.

Connect the power cable with the plug outlet of the following power specifications.

- Voltage : AC100 - 240V \pm 10%
- Frequency : 50/60Hz

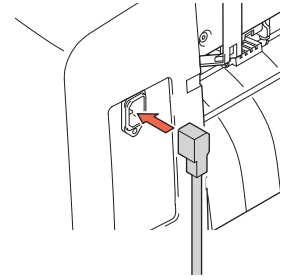

- **Be sure to connect the ground wire.**
- Using without the ground wire causes the damage of this device and electric shock that may be very dangerous.

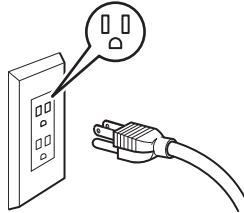

- **Regarding the use of two polar plug outlet, you must connect the auxiliary ground adapter to the plug of power cable.**

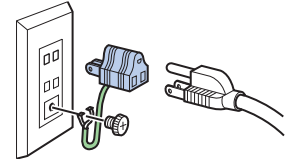

- Earth the green wire (ground wire) of the ground adapter. If you cannot, consult with an electrician.

Menu mode

This plotter is provided with the following four modes:

< NOT-READY > mode

The plotter is in this mode until the media is detected.
The keys other than the **REMOTE** key are effective.

< LOCAL > mode

The plotter enters this mode after the sheet detection.
All the keys are effective.

The plotter can receive data from the computer. However, data processing of cutting (plotting) and similar data is not performed.

(Doing so could result in a processing error depending on the application software.)

< REMOTE > mode

The plotter performs cutting (plotting) according to the received data.

Pressing the **REMOTE** key interrupts the cutting operation and returns the plotter to the LOCAL mode.

Pressing the **REMOTE** key once again resumes cutting.

Pressing the **ENTER/HOLD** key during cutting brings the plotter into the HOLD state. (P.3-48)

This indicates the amount of data received. Once cutting (plotting) is started, the amount of data will decrease in steps of 1 KB.

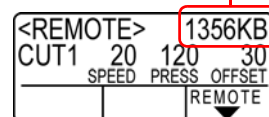

< FUNCTION > mode

To set the FUNCTION mode, press the **FUNCTION** key when the plotter is in the LOCAL mode.

Set various cutting (plotting) conditions in this mode.

If there is data for which cutting has not been finished yet, there is a case where you cannot change settings. In such a case, let the cutting finish or execute [DATA CREAR] first and then start changing the settings.

(P.3-48)

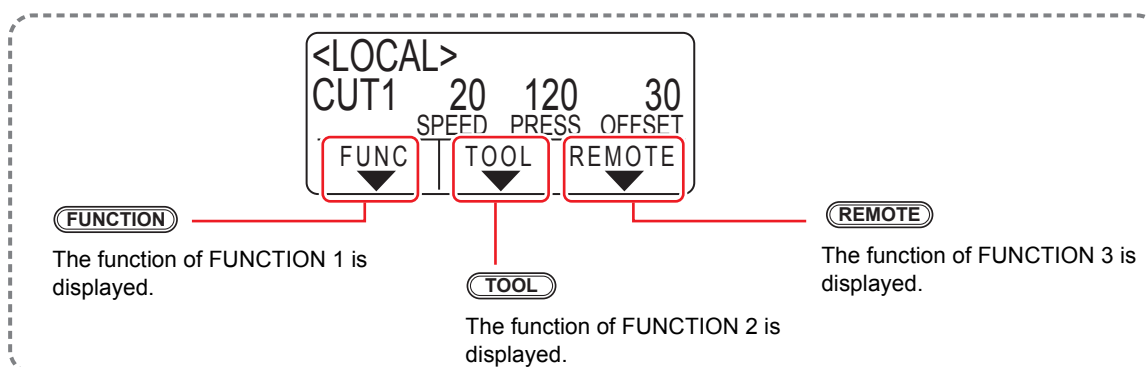

CHAPTER 2

Basic Operations



This chapter describes the procedures and settings ranging from tool installation to cutting (plotting) operation.

Installing a tool	2-3
Using a cutter	2-3
How to Install a Ballpoint Pen	2-6
Turning the power on	2-8
Setting the tool conditions	2-9
Kinds of the Tool Conditions	2-9
Select the tool condition	2-10
Set the Tool Conditions	2-10
Setting a sheet	2-14
Setting a leaf sheet (cut sheet)	2-17
How to Place the Roll Sheet (CG-60SRIII)	2-18
How to Place the Roll Sheet (CG-100SRIII/CG-130SRIII)	2-20
Test cutting (plotting)	2-23
Cutting (plotting)	2-25
Setting the origin	2-25
Start cutting (plotting)	2-26
Cut off the Sheet (Manual Cutting)	2-27
Turning the power off	2-28

Operation flow

1 Installing a tool

See "Installing a tool" (☞ P.2-3)

2 Turning the power on

See "Turning the power on"
(☞ P.2-8)

3 Setting the tool conditions

See "Setting the tool conditions"
(☞ P.2-9)

4 Setting a sheet

See "Setting a sheet"
(☞ P.2-13)

5 Test cutting (plotting)

See "Test cutting (plotting)"
(☞ P.2-22)

6 Cutting (plotting)

See "Cutting (plotting)" (☞ P.2-23)

7 Turning the power off

See "Turning the power off"
(☞ P.2-26)

Installing a tool

For this device, you can use the following tools.

Cutter : Select this to cut the image printed on a sheet and to create the cut letters with the cutting sheet.

Pen (rollerball) : Select this to “trial-write” for confirming how to cut.

Using a cutter



- Don't touch the cutter blade with your fingers.
->Sharp cutter tip may injure you.
- After setting the cutter, do not shake the cutter holder.
->The tip of the cutter may pop out and may injure you.
- Keep the cutter out of reach of children. Dispose of the used cutter blade in compliance with the applicable regulations.

How to install a cutter

1

Remove the cap located at the edge by rotating it.

2

Replace the cutter with a new one using tweezers or the like.

3

Turn the adjusting knob to adjust the protruding amount of the cutter.

- arrow to protrude the cutter blade.
(0.5 mm per revolution)

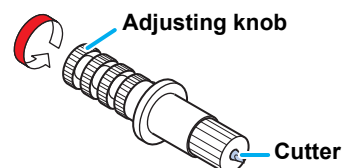
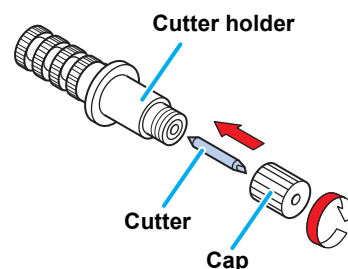

2

Basic Operations

Adjusting the protrusion of the cutter blade

Adjust the cutter blade according to the types of the cutters and the sheet for use.

After adjusting the protrusion of the cutter blade, set the cutting conditions and conduct test cutting to check the cutting quality.

For the cutter supplied with unit, the protruding amount of the blade can be adjusted with the cutter mounted in the pen carriage.

Important!

- Take care not to protrude the blade too much. If the cutter is used with its blade excessively protruded, the cutter can cut out the base paper, thus damaging the main unit.

1

Turn the adjusting knob to adjust the protruding amount of the cutter blade.

- arrow to protrude the cutter blade.
(0.5 mm per revolution)

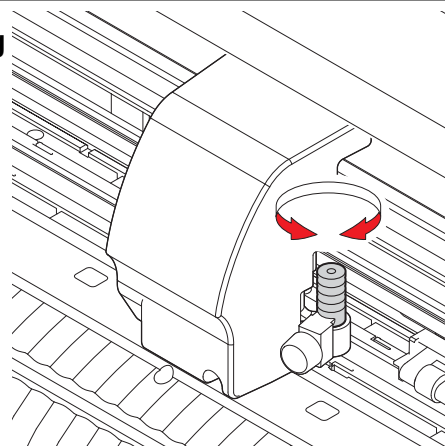

Important!

- See the appendix for the blade adjustment of the cutters other than the auxiliary products (P.5-4)

Protruding amount of the cutter blade

Amount of cutting = $\frac{\text{Film thickness} + \text{Base paper thickness}}{2}$

- However, Film thickness < Base paper thickness

For reference :

the protruding amount of the cutter blade = 0.2 to 0.5mm
(Replace the blade when it is blunt.)

Important!

- Adjust the blade pressure so that the cutter may leave a little bit of cutter track on the sheet.
- In case the sheet thickness is thinner than the film thickness, which may not provide correct cutting quality, change the protruding amount of the blade and you may get a better result.

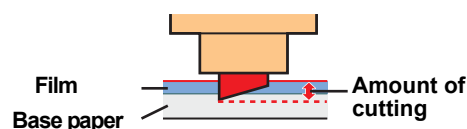
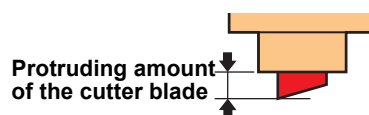

How to install the cutter holder

Important!

- Install the cutter holder to the tool holder of the carriage. Be sure to insert the cutter holder all the way in the tool holder.

1

Rotate the knob to loosen the holder presser.

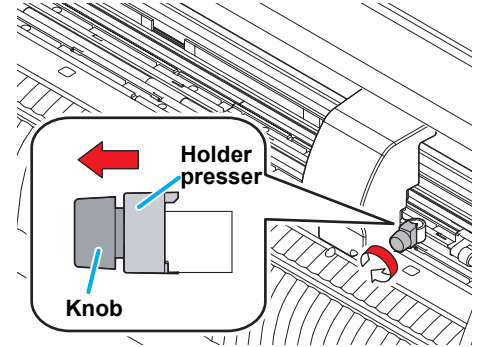

2

Insert the cutter holder into the tool holder.

- Push the brim of the cutter holder against the tool holder.
- Press the brim of the cutter holder with the holder presser.

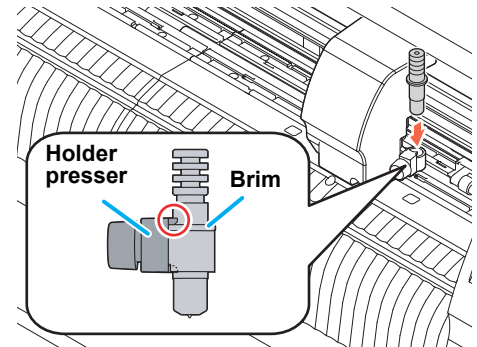

3

Fix the cutter holder.

- Turn the knob of the tool holder clockwise, and surely fix it.

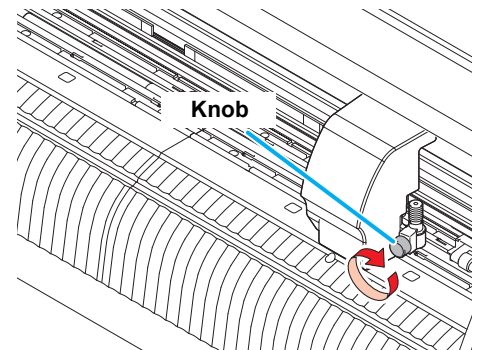

Important!

- Fix the cutter holder firmly. If not, accurate and high-quality cutting (plotting) will not be achieved.

2

Basic Operations

How to Install a Ballpoint Pen

Important!

- When you want to use a commercially available ballpoint pen, you must use the pen of 8mm to 9mm in diameter. Image quality may depend on the pen.
(Recommended ballpoint pen: the one available from Pentel Co., Ltd. with the product No.: K105-A, K105-GA)
- Regarding such ballpoint pens as shown below, the pen inclines to touch the cover when held by the pen adapter (the pen that the pen holder girth of which may vary, the pen that the pen holder of which has umbo and differences)



Uneven gauge

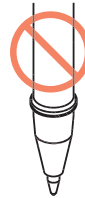

With steps or bumps

1 Put the cap on the pen adapter.

- Use the cap to adjust the pen height.

2 Insert the pen into the pen adapter.

- Insert the pen until the tip of the pen reaches the cap.

3 Fix the tip of the pen.

- Tighten the fixing screw clockwise.
- Be careful not to over-tighten the fixing screw for the pen adapter. If tightened too much, the ball-point pen may crack.

4 Remove the cap.

5 Rotate the knob to loosen the holder presser.

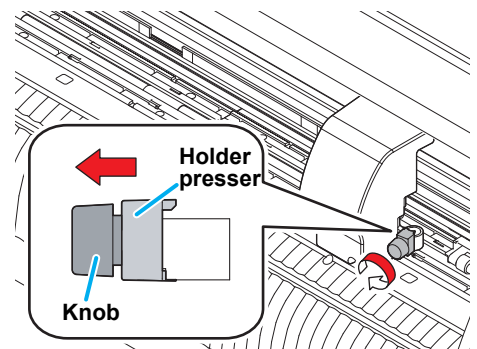
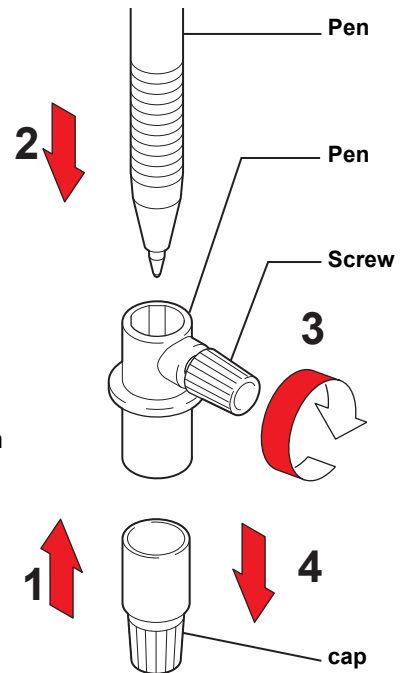

6**Insert the pen adapter with the pen into the tool holder.**

- Make sure that the brim of the pen adapter is rested on the tool holder.
- Set the adapter in such a way that the fixing screw will not obstruct operation.
- Press the brim of the pen adapter with the holder presser.

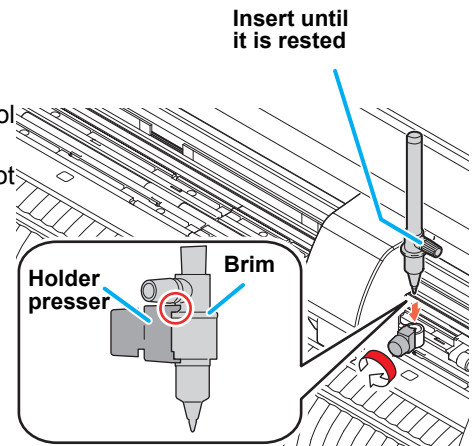
**7****Turn the knob clockwise to fix the tool.**

Turning the power on

Important!

- Before turning the power on, check that the pinch rollers have been raised.
- Be sure to turn on the host computer before turning on the plotter. If this order is not correctly followed, the plotter can malfunction.
- Once the power is turned off, wait at least five seconds before turning the power on again.

1

Press the “ | ” side of the power switch.

- When the plotter is turned on, it will enter the first operation mode, which are followed by the subsequent modes. Refer to P.1-11 for the operation modes.
- The POWER indicator lamp lights up in blue.
- The machine performs its initial operation.

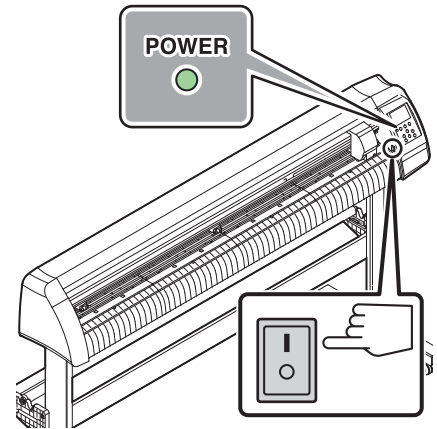

2

After the origin detecting operation, the tool condition currently selected is displayed.



CG-SR3	Start-up	
ver 1.00		
↓		
<LOCAL>		
CUT1	20 120 30	
	SPEED PRESS OFFSET	
FUNC	TOOL	REMOTE

Setting the tool conditions

You can register the cutting speed and the pressure depending on the sheet or the tool type to be used. (Tool condition)

Kinds of the Tool Conditions

A tool condition consists of cutting conditions (CUT1 to CUT7), printing-with-a-pen condition (PEN).

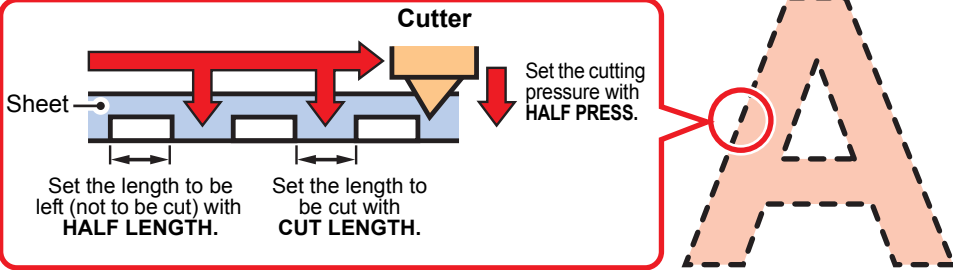
Kinds	Description																								
<p>Cutting Condition (CUT1 to 7)</p>	<p>This is a tool condition when a cutter is used.</p> <p>When you press the  key, it moves to the half cut condition.</p> <div style="display: flex; justify-content: space-around;"> <div style="text-align: center;"> <p><CUT CONDITION></p> <table border="1" style="border-collapse: collapse; text-align: center;"> <tr><td>CUT1</td><td>20</td><td>120</td><td>30</td></tr> <tr><td>SPEED</td><td></td><td>PRESS</td><td>OFFSET</td></tr> <tr><td>FUNC</td><td>TOOL</td><td>REMOTE</td><td></td></tr> </table> </div> <div style="text-align: center;"> <p></p> <p><CUT CONDITION></p> <table border="1" style="border-collapse: collapse; text-align: center;"> <tr><td>ON</td><td>8</td><td>2.0</td><td>60</td></tr> <tr><td>HALF</td><td>H-PRES</td><td>H-LENG</td><td>C-LENG</td></tr> <tr><td>FUNC</td><td>TOOL</td><td>REMOTE</td><td></td></tr> </table> </div> </div> <p>OFFSET The distance from the center of the cutter holder to the cutter blade. (0.01mm)</p> <p>PRESS The pressure required for cutting. (g)</p> <p>SPEED The speed of cutting.</p> <p>Cutting condition No.(1 to 7)</p> <p>HALF Valid (ON) or invalid (OFF) of half cut.</p> <p>CUT LENGTH Length to be cut. (mm)</p> <p>HALF LENGTH Length to be left (not to be cut). (mm)</p> <p>HALF PRESS Pressure of left part. (g)</p> <p>About Half Cutting</p> <p>You can cut on the dotted line, not to cut sheet out. (Half cut) When you set half cut to valid (ON), you can use the half cut function. The cutting condition changes from CUT to HLF when Half Cut is changed to "Valid (ON)".</p> <div style="border: 2px solid red; padding: 10px; margin: 10px 0;">  </div> <p>Important! • The illustration above is the image. The shape of cut surface differs depending on the cutting conditions.</p>	CUT1	20	120	30	SPEED		PRESS	OFFSET	FUNC	TOOL	REMOTE		ON	8	2.0	60	HALF	H-PRES	H-LENG	C-LENG	FUNC	TOOL	REMOTE	
CUT1	20	120	30																						
SPEED		PRESS	OFFSET																						
FUNC	TOOL	REMOTE																							
ON	8	2.0	60																						
HALF	H-PRES	H-LENG	C-LENG																						
FUNC	TOOL	REMOTE																							
<p>Plotting Condition (PEN)</p>	<p>This is a tool condition when the pen is used.</p> <div style="text-align: center;"> <p><CUT CONDITION></p> <table border="1" style="border-collapse: collapse; text-align: center;"> <tr><td>PEN</td><td>20</td><td>120</td><td></td></tr> <tr><td>SPEED</td><td></td><td>PRESS</td><td>OFFSET</td></tr> <tr><td>TOOL</td><td></td><td></td><td></td></tr> </table> </div> <p>PRESS The pressure required for plotting. (g)</p> <p>SPEED The speed of plotting.</p>	PEN	20	120		SPEED		PRESS	OFFSET	TOOL															
PEN	20	120																							
SPEED		PRESS	OFFSET																						
TOOL																									

Select the tool condition

Before cutting (plotting), select the tool condition depending on the sheet and the tool type to be used.

1 Press the **TOOL** key in LOCAL mode.

<CUT CONDITION>			
CUT1	20	120	30
SPEED PRESS OFFSET			
FUNC	TOOL	REMOTE	
	▼		

2 Press the **TOOL** key to select a tool condition to be used.

- Each time you press the **TOOL** key, the tool condition is switched as follows.

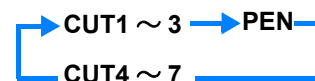

3 Cutting (plotting). (☞ P.2-22)

Set the Tool Conditions

Set the condition to cut or to plot with a pen.

Setting contents of cutting condition (CUT1 to 7) : Cut speed (SPEED)/ cut pressure (PRESS)/ OFFSET value/ Half cut

Setting contents of plotting condition (PEN) : Plotting speed (SPEED)/ pen pressure (PRESS)

1 Press the **TOOL** key in LOCAL mode.

<CUT CONDITION>			
CUT1	20	120	30
SPEED PRESS OFFSET			
FUNC	TOOL	REMOTE	
	▼		

2 Press **TOOL** the key to select a tool condition to be set.

<CUT CONDITION>			
CUT2	20	50	30
SPEED PRESS OFFSET			
	TOOL		
	▼		

3 Press **▲▼** to set the cutting (plotting) speed.

- Set the moving speed of the tool for cutting or pen plotting.
- **Setting values** : 1 to 10cm/s (settable by 1cm/s step)
15 to 70cm/s(settable by 5cm/s step)

<CUT CONDITION>			
CUT2	50	50	30
SPEED PRESS OFFSET			
	TOOL		
	▼		

4 Press **▶** to move the cursor to cutting (plotting) pressure (PRESS).

<CUT CONDITION>			
CUT2	50	50	30
SPEED PRESS OFFSET			
	TOOL		
	▼		

5 Press to set the cutting (plotting) pressure.

- Set the pressure that the tool presses the sheet for cutting or pen plotting.
- Setting values** : 10 to 20g (settable by 2g step)
25 to 100g (settable by 5g step)
110 to 500g (settable by 10g step)



- When the cutting (plotting) pressure setting is completed, proceed to the setting of the OFFSET value. When you set the plotting condition (PEN), you cannot set the OFFSET value and half cut. Proceed to the Step 16.
- The maximum pressure at selecting PEN is 150g.

<CUT CONDITION>			
CUT2	50	80	30
	SPEED	PRESS	OFFSET
	TOOL		

6 Press to move the cursor to OFFSET.

<CUT CONDITION>			
CUT2	50	80	30
	SPEED	PRESS	OFFSET
	TOOL		

7 Press to set the offset value .

- When you set the cutting condition (CUT1 to 7), set the distance between the center of the cutter holder and the blade tip.
- Setting values** : 0 to 250 (0.00 to 2.50mm)
(settable by 0.05mm step)



- Nothing is displayed on the LCD if "0" is specified.

<CUT CONDITION>			
CUT2	50	80	35
	SPEED	PRESS	OFFSET
	TOOL		

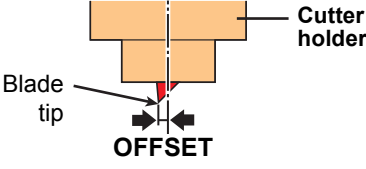

8 Press to move the cursor to half cut ON/OFF.

<CUT CONDITION>				
OFF	0	1.0	100	
	HALF	H-PRES	H-LENG	C-LENG
	FUNC	TOOL	REMOTE	

9 Press to set ON/OFF .

- When you perform half cut, select ON and proceed to the Step 10.
- When you do not want to set AUTO CUT, select "OFF" and proceed to Step 16.

<CUT CONDITION>				
ON	0	1.0	100	
	HALF	H-PRES	H-LENG	C-LENG
	FUNC	TOOL	REMOTE	

10 Press to move the cursor to pressure setting of left part (not to be cut).

<CUT CONDITION>				
ON	0	1.0	100	
	HALF	H-PRES	H-LENG	C-LENG
	FUNC	TOOL	REMOTE	

11 Press to set pressure .

- Set the pressure of the left part (not to be cut) when performing half cut.
- Setting values** : 0 to 300g (settable by 5g step)

<CUT CONDITION>				
ON	0	1.0	100	
	HALF	H-PRES	H-LENG	C-LENG
	FUNC	TOOL	REMOTE	

12 Press key to move the cursor to the setting of length to be left.

<CUT CONDITION>				
ON	0	1.0	100	
	HALF	H-PRES	H-LENG	C-LENG
	FUNC	TOOL	REMOTE	

13 Press   to move the cursor to the setting of length to be left.

- Set the length to be left not to be cut when performing half cut.
- **Setting values** : 1 to 5mm (settable by 0.1mm step)

<CUT CONDITION>			
ON	0	2.0	100
HALF	H-PRES	H-LENG	C-LENG
FUNC	TOOL	REMOTE	

14 Press  to move the cursor to the setting of cut length.

<CUT CONDITION>			
ON	0	2.0	100
HALF	H-PRES	H-LENG	C-LENG
FUNC	TOOL	REMOTE	

15 Press   to set the cut length.

- Set the length to be cut when performing half cut.
- **Setting values** : 5 to 150 mm
(5 to 20mm: 1mm step, 20 to 150mm: 5mm step)

<CUT CONDITION>			
ON	0	2.0	150
HALF	H-PRES	H-LENG	C-LENG
FUNC	TOOL	REMOTE	

16 Press the  key to register the set contents.

- Return to the local mode.

Important!

- The set value is retained even when the power is turned "OFF".

Setting a sheet

Either a leaf sheet (cut sheet) or a roll sheet can be loaded on the plotter. The pinch rollers and grit rollers hold the sheet in position. Locate the pinch rollers so that they match the sheet to be used.

Important!

- CG-100SRIII/ CG-130SRIII have three pinch rollers (CG-60SRIII has two). When setting a slippery surface material, such as a soft sheet, wider sheet, or film, set a pinch roller to the both sheet ends and the center. For a narrow sheet, no need to set the pinch roller in the center of the sheet.
- When in use of the center pinch roller, it may have the mark of the grit roller in the sheet.

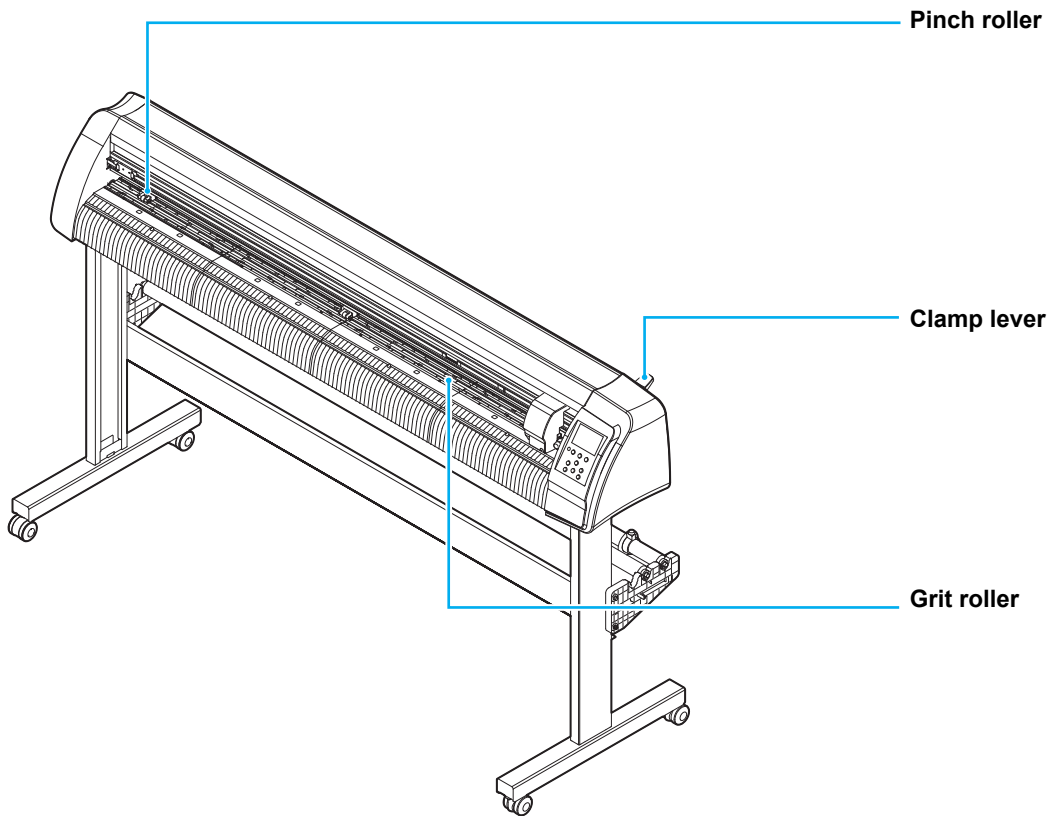

Sheet width

	mm	inch
CG-60SRIII	90 to 740	3.55 to 29.10
CG-100SRIII	90 to 1250	3.55 to 49.20
CG-130SRIII	90 to 1550	3.55 to 61.00

Maximum cutting area

The maximum cutting area (the area in which cutting (plotting) is permitted) varies depending on the location of pinch rollers and that of the origin. The white portion of the illustration shown below represents the maximum cutting area. (P.2-23)
An area where cutting is not permitted is called a "non-plotting area".

Important!

- In expand mode, the area defined with the outer edges of the pinch rollers is detected.
- In normal mode, the area defined with the inner edges of the pinch rollers is detected. (P.3-35)

	The origin is set at the lower right corner of the area.	The origin is set at the center of the area.
CG-60SRIII	0.606m X 51m	0.606m X 5m
CG-100SRIII	1.07m X 51m	1.07m X 5m
CG-130SRIII	1.37m X 51m	1.37m X 5m

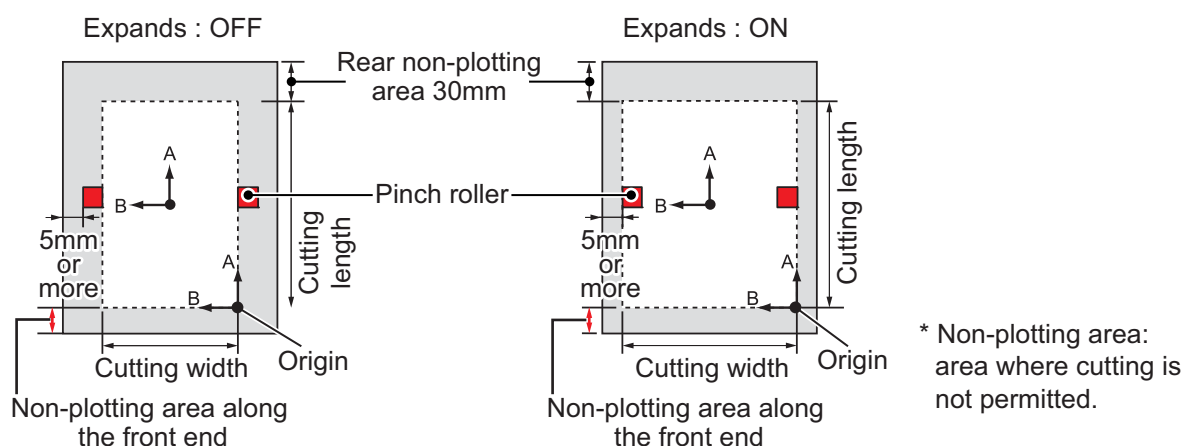

Sheet detection

The width and length of the sheet are detected by pressing or depending on the sheet loaded. (P.2-14)

Important!

- Once the sheet length has been detected, if the received data is larger than the sheet, the portion of data that exceeds the sheet cannot be used for cutting. If the sheet length is not detected, the plotter will terminate cutting operation when data goes beyond the sheet.
- If the sheet sensor function is set to [OFF], a press of a jog key will make the plotter perform the same sheet detection as the case key is pressed. (Only the sheet width is detected.)
- The maximum length that can be detected at the rear ends of the sheet of media is 5m.

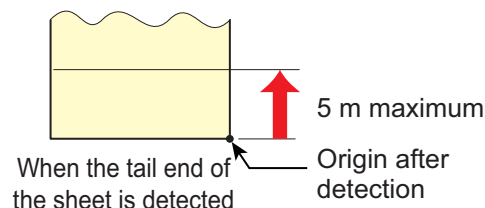



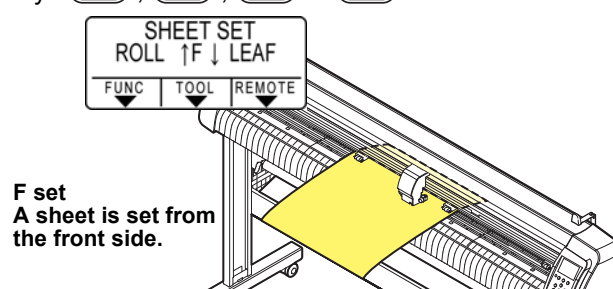
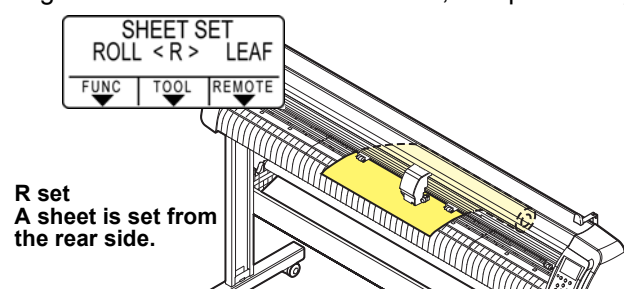

Method of detecting a sheet



When a sheet of media is set, the following two displays will appear alternately on the LCD panel. Align to the direction of the set sheet, and press the jog keys , , or .

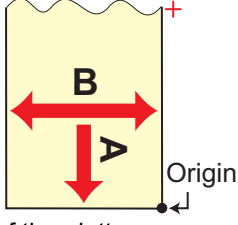
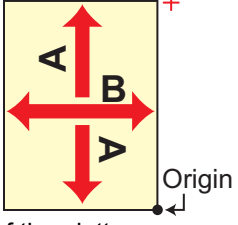
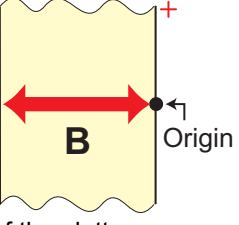

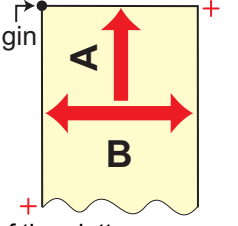
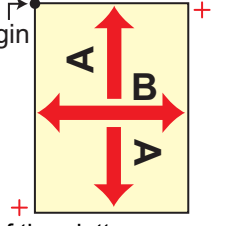
The plotter uses the five different methods to detect a sheet of media as shown below.

<p>Key</p>	<p> Sets the roll sheet in the back.</p>	<p> Sets the leaf sheet in the back.</p>	<p> Detects only the sheet width.</p>
<p>Detecting method</p>	<p>After the sheet width is detected, the front end of the sheet is detected.</p>  <p>Front of the plotter</p>	<p>After the sheet width is detected, the front and back end of the sheet is detected.</p>  <p>Front of the plotter</p>	<p>The sheet width is detected.</p>  <p>Front of the plotter</p>
<p>Example of display after the sheet detection</p>	<p><LOCAL> A ***.* B 123.0 FUNC TOOL REMOTE</p>	<p><LOCAL> A 567.0 B 123.0 FUNC TOOL REMOTE</p>	<p><LOCAL> A ***** B 123.0 FUNC TOOL REMOTE</p>
<p>Key</p>	<p> Sets the roll sheet in the front.</p>	<p> Sets the leaf sheet in the front.</p>	
<p>Detecting method</p>	<p>After the sheet width is detected, the back end of the sheet is detected.</p>  <p>Front of the plotter</p>	<p>After the sheet width is detected, the front and back end of the sheet is detected.</p>  <p>Front of the plotter</p>	
<p>Example of display after the sheet detection</p>	<p><LOCAL> A ***** B 123.0 FUNC TOOL REMOTE</p>	<p><LOCAL> A ***** B 123.0 FUNC TOOL REMOTE</p>	



- When the detected length is 3 m or more, “*****” will appear on the LCD.
- Be careful if only detecting sheet width by using the  key as it is possible that the sheet could fall out if advancing the sheet using the jog key  .
- Note that the directions of the + (plus) of each axis differ as shown in the illustration above, depending on what direction the sheet is set.
- The status when sheet detection is performed is the same as that after executing DATA CLEAR. The status when sheet detection is performed is the same as that after executing DATA CLEAR. (Copies can be made.)
- Be sure to always perform sheet detection in FineCut “Leaf Mode” when cutting continuously with the registration mark.
If the front end of the sheet is not detected, a parameter error occurs and the printer does not enter copy mode.



- When a long sheet of media is used or a sheet which has already been drawn out is used from its middle area, the sheet detection will require an extended period of time. In such a case, the detection time can be reduced by detecting only the sheet width  key.

Setting a leaf sheet (cut sheet)

1

Press the **SHEET SET** key to switch to NOT READY mode.

- You need not to do so if it is already in the NOT READY mode. Start operation from the Step 2.



2

Load the leaf sheet on the platen.

- (1) Move down the clamp lever to the rear and raise the pinch rollers.
- (2) Set the right end of the sheet considering the platen vertical rib as the measure.
Or, align the near end of the sheet in parallel with the platen.

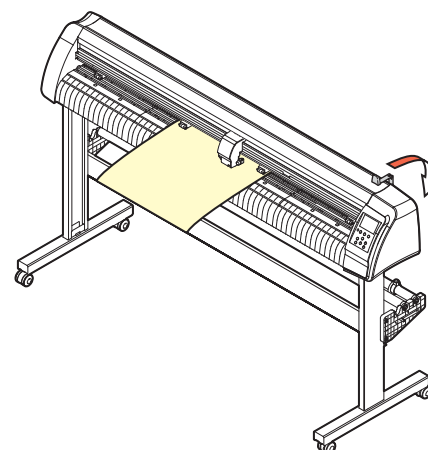
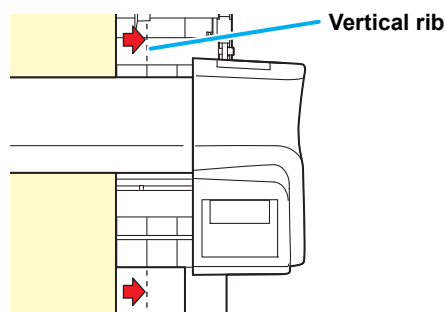

3

Move the pinch rollers fitting to a width of the sheet.

- Locate each of the pinch rollers 5 mm or more inside the sheet edge; otherwise, the sheet can slip off the pinch rollers while it is being fed.

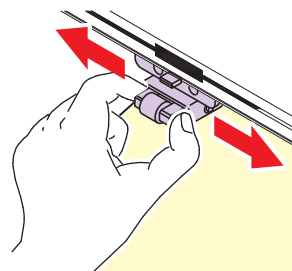

4

Move down the clamp lever to the front and move the pinch rollers down.

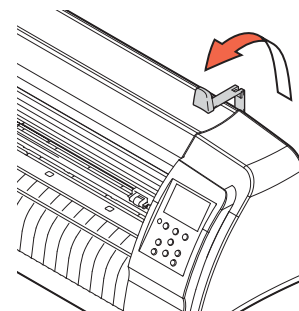

5



Press the jog key or to select "LEAF".

- For "Sheet detection" (P.2-14)
- : In the case the sheet is loaded from the rear
- : In the case the sheet is loaded from the front

Important!

- When you press the **FEED** key, the screen to select the number of pinch rollers is displayed before sheet detection. After selecting the pinch roller, sheet detection is performed.
- The number of pinch rollers set here has priority over the one selected from [SET UP] - PINCH ROLL.] menu.

6

Press the jog key  or  to select number of pinch rollers to be used. (CG-130SRIII)

- When [ROLL. SELECT] is set to [ON], select the number of pinch rollers to be used. (☞ P.3-56)



7

Start detecting the sheet.

- When [DUMMY CUT] is set to [ON], after completing the sheet detection, the plotter performs dummy cutting operation (☞ P.3-83).
- This plotter cannot detect the leaf sheet of longer than 5m.

Displays the detected size of the leaf sheet.

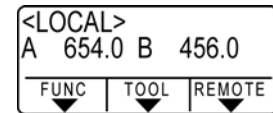

Unit : mm

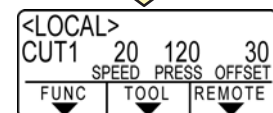

Displays the current settings of tool conditions.

How to Place the Roll Sheet (CG-60SRIII)

If you want to use the roll sheet, you must mount the roll-placing table.

1

Move down the clamp lever to the rear.

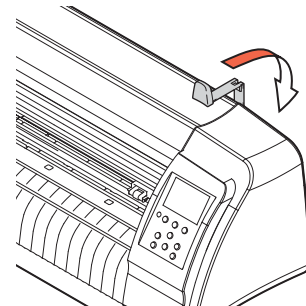

2

Lay down the roll-placing table, fitting to the width of the roll sheet.

- As the roll-placing table has a magnet, just attach it to the device and it is fixed.
- Fix the roll-placing table 2 to 3mm away from the sheet width. Pressing the both ends hard may cause the roll not to be rotated, resulting in no sheet feeding.

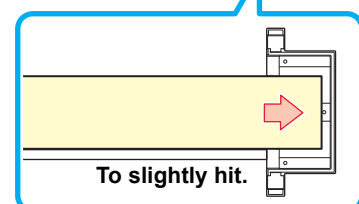
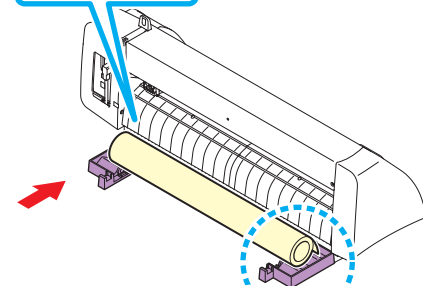
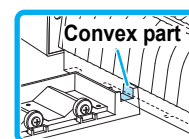

3

Lay up the roll sheet on the roll-placing table.

- Be careful about the sheet direction.

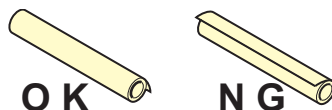

4

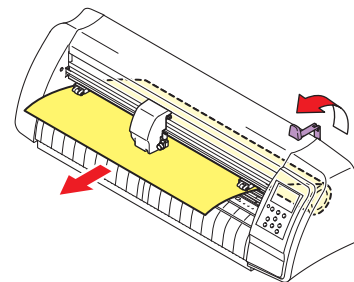

Pull out the sheet for maintaining.

- (1) Pull the sheet tightly and take up the slack.
- (2) Check that the sheet is set without slacks and then move down the clamp lever to the front.
- When the power is on, the absorbing fan is turned on to absorb the roll sheet.
- If the power is not on, the absorbing fan is not turned on. Therefore, pressing the sheet with your left hand so as not to be deformed, raise the clamp lever.



5

Press the jog key or to select [ROLL].

- "Sheet detection" ( P.2-14)
 -  : In the case the sheet is loaded from the rear
 -  : In the case the sheet is loaded from the front
- Important!**
- When you press the **FEED** key, the screen to select the number of pinch rollers is displayed before sheet detection. After selecting the pinch roller, sheet detection is performed.
 - The number of pinch rollers set here has priority over the one selected from [SET UP] - PINCH ROLL.] menu.

6

Start detecting the sheet.

- After displaying the sheet width, the plotter performs the dummy cutting operation ( P.3-69).

Displays the detected size of the leaf sheet.

```
<LOCAL>
A  *.*.* B  420.0
-----
FUNC  TOOL  REMOTE
```

Unit : mm

```
<LOCAL>
CUT1  20  120  30
      SPEED PRESS OFFSET
-----
FUNC  TOOL  REMOTE
```

Displays the current settings of tool conditions.

7

Perform [FEED] and pull out the sheet of the length you use. (P.3-47)

Important!

- Before you use the roll sheet, previously pull out the sheet of the length you use to make enough room. By feeding out the sheet, you can verify if there is any sheet misalignment or not.

How to Place the Roll Sheet (CG-100SRIII/CG-130SRIII)

If you want to use the roll sheet, you must mount the roll-placing table.

1 Move down the clamp lever to the rear.

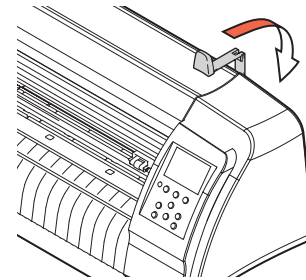

2 Set the roll bars on the roll stays.

- Set each roll bar so that the side provided with a projection is located on the left side as viewed from the rear of the plotter. Select the groove 1 or 2 to set one of the roll bars depending on the outside diameter of the roll sheet to be used.
- If the outside diameter of the roll sheet is 3 inch or more, place the roll bars in the grooves 1 and 3.
- If the outside diameter of the roll sheet is less than 3 inch, place the roll bars in the grooves 2 and 3.

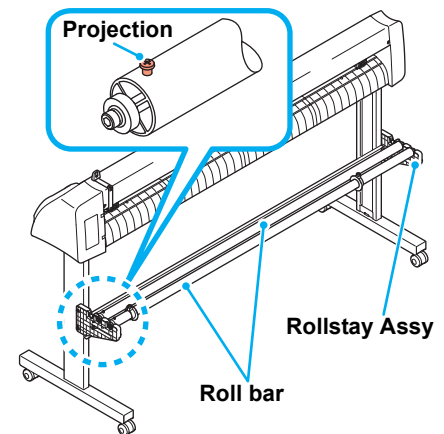
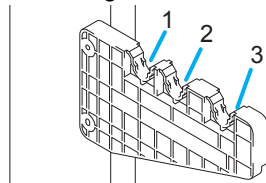

Important!

- Keep the roll bars level when lifting up to move the groove in which the roll bars are set. Lifting up a roll bar at an angle can damage the rollstay Assy.

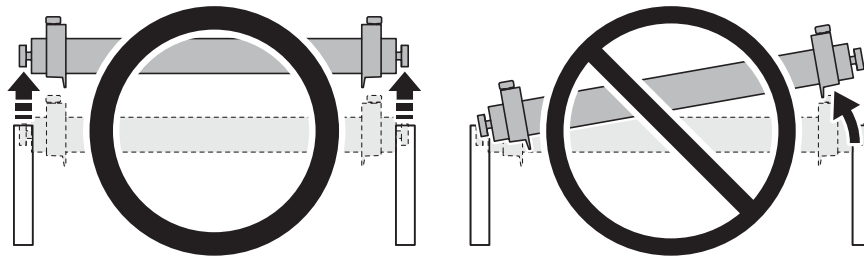

3 Load a roll sheet.

- (1) Place a roll sheet on the roll bars.
 - (2) Pass the leading edge of the sheet onto the platen and adjust the location of the pinch rollers to the sheet width.
- Locate each of the pinch rollers 5 mm or more inside the sheet edge; other-wise, the sheet can slip off the pinch rollers while it is being fed.

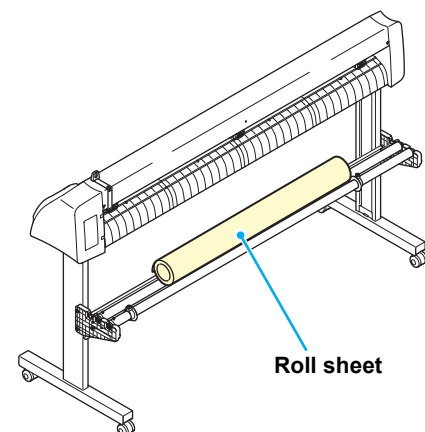
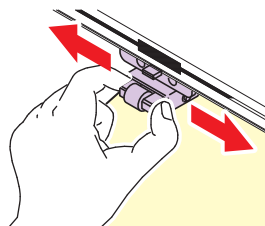

4**Retain the roll sheet with the roll holders.**

- Move the roll holders to both ends of the roll, respectively, and secure them by tightening the screws.
- Locate the roll holders 2 to 3 mm away from the respective roll ends. If the roll holders are fixed pressed against the roll ends, there may be a case where the roll cannot turn and thus the sheet cannot be feed.

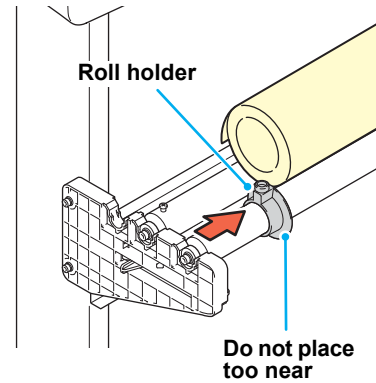
**5****Lock the roll stopper.**

- Push the lock lever toward the rear of the main unit to lock the stopper.
- The roll stopper prevents the roll from turning when you draw out the sheet.

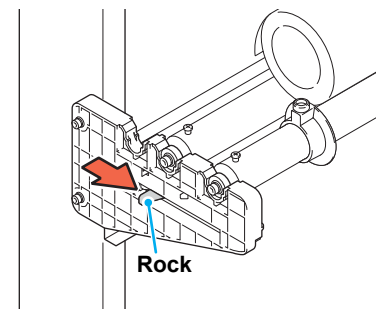
**6****Hold the sheet.**

- (1) Pull the sheet to take up the slack in it.
 - (2) Check that the sheet is set without slacks and then move down the clamp lever to the front.
- If the plotter has been turned on: The suction fan will rotate to retain the sheet by suction.
 - If the plotter has been turned off: The suction fan will not rotate. It is, therefore, necessary to tilt the clamp lever toward the front of the unit while retaining the sheet with your left hand to prevent the sheet from warping.

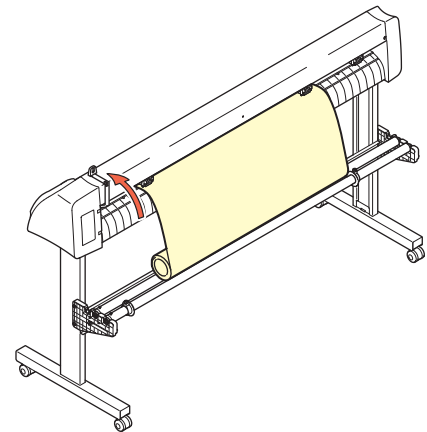

**7****Release the roll stopper.**

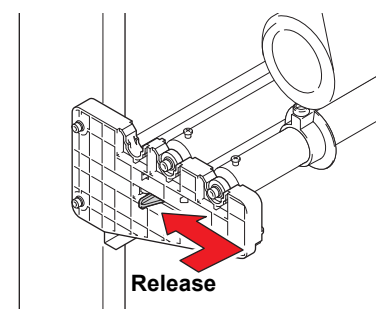
- Push and pull the stopper to the front of the plotter.
- If you do not release the roll stopper, the buzzer sounds during sheet feeding and the plotter stops.



8



Press the jog key  or  to select [ROLL].

- For “Sheet detection” (☞ P.2-14)
-  : In the case the sheet is loaded from the rear
-  : In the case the sheet is loaded from the front

Important!

- When you press the  key, the screen to select the number of pinch rollers is displayed before sheet detection. After selecting the pinch roller, sheet detection is performed.
- The number of pinch rollers set here has priority over the one selected from [SET UP] - PINCH ROLL.] menu.

9

Press the jog key  or  to select number of pinch rollers to be used. (CG-130SRIII)

- When [ROLL. SELECT] is set to [ON], select the number of pinch rollers to be used. (☞ P.2-14)



10

Press the  key.

11

Perform [FEED] and pull out the sheet of the length you use. (☞ P.3-47)

Important!

- Before you use the roll sheet, previously pull out the sheet of the length you use to make enough room. By feeding out the sheet, you can verify if there is any sheet misalignment or not.

2

Test cutting (plotting)

Execute test cutting (plotting) to confirm the tool conditions.
In the test cutting, the plotter cuts two squares.

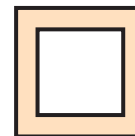

Important!

- When the cutter blade is worn and dull, you can use it temporarily by enhancing the value of PRESSURE. However, you are recommended to replace the worn cutter blade with a new one to ensure a satisfactory cutting quality.



- When the tool conditions are proper, the results of test cutting (plotting) are as follows:
- The two squares are cut perfectly.
- The base sheet remains uncut.
- No corner of the squares is rounded.
- No corner of the squares is curled-up.

1

Confirm that the plotter is in the local mode.

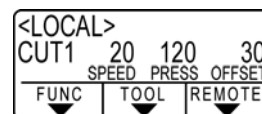

2

Press the **[FUNCTION]** key a few times to select **[SQUARE CUT]**.

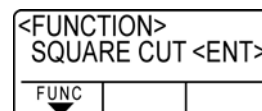

3

Press the **[ENTER/HOLD]** key .

- The plotter will execute test cutting (plotting) and then return to the local mode display.

Change the settings of the cut conditions according to the test cutting (plotting) results.

Cut Condition	Cause	Solution
Some parts uncut.	The blade is lifted above the sheet because of a too high cutting speed.	Lower the speed. (☞ P.2-10).
		Tighten up the knob for the tool holder. (☞ P.2-5).
The base sheet has been cut.	Too high pressure.	Lower the pressure. (☞ P.2-10).
	Too large protrusion of the cutter blade.	Adjust the protrusion of the cutter blade. (☞ P.2-4).
Any of the square corners rounded.	Improper OFFSET value.	Adjust the OFFSET value so that it suits the cutter blade in use. (☞ P.2-10).
Any of the square corners curled-up.	The protruded cutter blade is too much. The cutting pressure is higher. The [COMPENSATION PRESSURE OFFSET value] is large. More than two out of the above fall under this category.	Adjust the protrusion of the cutter blade. (☞ P.2-4).
		Adjust the cutting pressure. (☞ P.2-10).
		Adjust the ADJ-PRS OFS value. (☞ P.3-78, P.3-83).

Cutting (plotting)

You can start cutting (plotting) after completion of setting up a tool, a sheet and the tool conditions.



- Check the following settings before cutting (plotting).
 Setting of the origin (☞ P.2-23)
 Setting of the command origin (☞ P.3-77)
 Switching between commands (☞ P.3-77)
 Priority of commands (☞ P.3-77)
 Setting of the maximum size response value (☞ P.3-77)

Setting the origin

The origin is a reference point for the cutting (plotting) data.
 When the origin is changed, set the new origin before starting cutting (plotting).



- Change the origin before cutting the next data; otherwise, cutting will be performed over the previous data.

1

Move the carriage to a point at which the new origin is to be set.

- : Moves the carriage to the right.
- : Moves the carriage to the left.
- : Feeds the sheet to the rear of the plotter.
- : Feeds the sheet to the front of the plotter.
- Every time you press the **TOOL** key, the tool will move up and down alternately. This helps you to set the origin at a correct position.

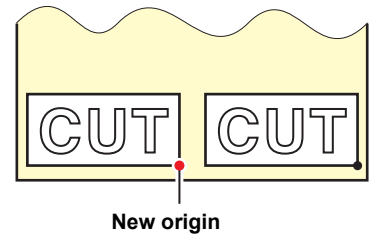

2

Press the **ENTER/HOLD key to register the origin.**

- The display panel will show the effective cutting area first and then the tool conditions.

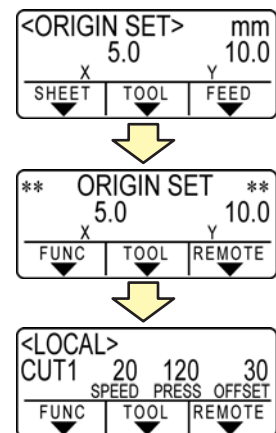

2

Basic Operations

Start cutting (plotting)

1

After completion of setting the origin, press the **REMOTE** key.

- The display changes to REMOTE.

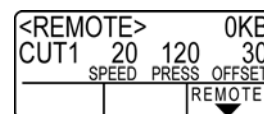

2

Send the data to the plotter.

- On receiving the data, the plotter performs cutting (plotting) while displaying the remaining amount of the data.
- Upon completion of cutting (plotting), the display changes as shown at right.

When the cutter is selected

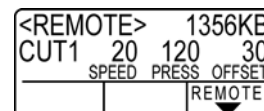

When the pen is selected

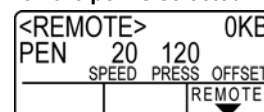

Bringing the cutting (plotting) to a halt

To temporarily stop the plotter during cutting (plotting), press the **REMOTE** key once. Another press of the key will make the plotter resume cutting (plotting).

Important!

- In case the sheet has slipped off the plotter during cutting operation, turn off the power immediately; otherwise, the main unit may be damaged.



- The LCD will show the following error message if you try to execute any function that can initiate some action during temporary suspension or any operation that can affect the command coordinate system.

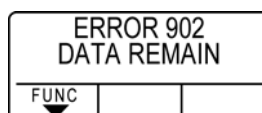

- If the error message appears, let the plotter complete the cutting for the remaining portion of the data or discontinue the cutting by executing data clearing (☞ P.3-48).

Cut off the Sheet (Manual Cutting)

1**Hold the sheet by hand.**

- Make sure to hold firmly to avoid the sheet raiseup.

2**Cut the sheet.**

- Cut the sheet with a cutter knife in the slot on the platen.

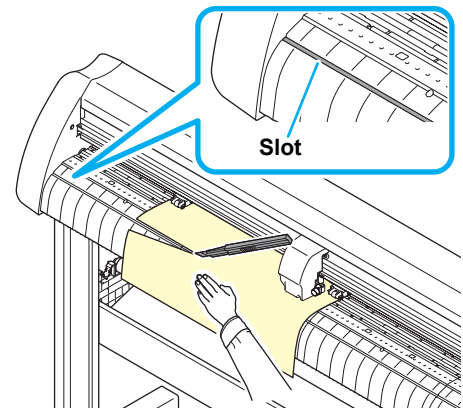

Turning the power off

When plotting is completed, press the “ O ” side of the power switch to turn the power off.

Important!

- Once the power is turned off, wait at least five seconds before turning the power on again.

1

Confirm that the plotter is not receiving any data.

- Make sure that the display is indicating REMOTE or LOCAL.

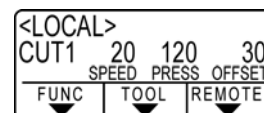
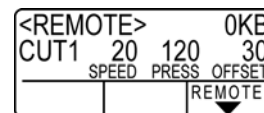

2

Press the “ O ” side of the power switch.

- The POWER lamp on the operation panel turns off.

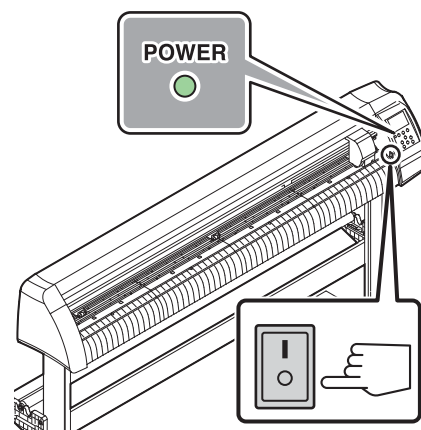

CHAPTER 3





Useful Function



This chapter describes the setting procedures of each functions, and how to operate the plotter usefully.

Functions in the Jog Mode	3-2	Change the cutting (plotting) order ...	3-44
Setting the origin	3-2	Set SORTING	3-44
Two-point axis alignment	3-3	Sorting sequence	3-46
Cutting area	3-4	Other Useful Functions	3-47
Digitization operation	3-5	Feed the paper	3-47
Set the distance compensation	3-6	HOLD	3-48
Perform Multiple Cuttings	3-9	DATA CLEAR - Discontinue Plotting -	3-48
Cut Out Data with Registration Mark .	3-11	Perform SAMPLE CUT to Find out the Cause	
The Flow of Cutting out		of Cutting Error.	3-49
the Registered Data	3-11	Output the Setting List	3-50
Enter the registration mark		Output the received data by the ASCII code	
detection mode	3-11	[ASCII DUMP]	3-51
Precautions in inputting data with		Set the configurations with a computer	3-52
registration marks	3-12	Make the media without uncut area	3-54
Set for Detecting the Registration Marks	3-16	Select the number of pinch roller to use ..	3-56
Method of detecting registration marks	3-21	Setting the FEED OFFSET	3-57
Confirm the following when failed in cutting		Setting the FEED SPEED	3-58
correctly.	3-29	Setting the PRE FEED	3-59
Expand the cutting (plotting) area	3-35	Set the network	3-61
Set the EXPANDS function to ON.	3-35	Setting event mail function	3-63
Switch the cutting (plotting) direction	3-37	Miscellaneous Settings	3-74
The Setting of ROTATION.	3-37	Switch the display language	3-74
Perform DIVISION cut	3-39	Switch the User	3-75
Set the Y direction (width direction)		Other Convenient Settings	3-76
DIVISION cut	3-39	Copy the set value	
Set the X direction (feeding direction)		from the other user setting.	3-84
DIVISION cut	3-41	Reset the setting values	
Cut Data via DIVISION CUT.	3-43	to the initial state.	3-85

Functions in the Jog Mode

Press the jog key , ,  or  in the local mode, and then you can enter the jog mode, where you can perform the following settings.

Function names	Contents	Reference page
Setting the origin	Set the point from which the plotter will start cutting (plotting).	P.3-2
Two-point axis alignment	If a ruled sheet is set, align the horizontal and vertical axes with the appropriate lines on the sheet.	P.3-3
Cutting area	Set the area in which the plotter performs cutting (plotting).	P.3-4
Up and Down of the Pen	This is to put up and down the tool. (Press the  key in the jog mode).	-

Important!

- Before you set the function in the jog mode, be sure to confirm that there is no cutting (plotting) data.
- When the origin or any other point is set in the jog mode, the center of the tool corresponds to the setting point regardless of the light pointer on/off.

Setting the origin

1

Press the  key to set to the local mode.

- Confirm in advance that if you press the  key to enter the remote mode, the plotter does not perform cutting (plotting).

```
<LOCAL>
CUT1  20 120 30
      SPEED PRESS OFFSET
FUNC  TOOL  REMOTE
```

2

Press the jog key , ,  or  to enter the jog mode.

- Press either one of the jog keys, and you can enter the jog mode.

```
<ORIGIN SET> mm
          0.0  0.0
          X    Y
SHEET  TOOL  FEED
```

3

Press the jog key , ,  or  to set the origin.

4

Press the  key to decide the origin.

- After displaying the effective cutting for while, the plotter returns to the local mode.

```
**  ORIGIN SET  **
          5.0  10.0
          X    Y
FUNC  TOOL  REMOTE
```



```
<LOCAL>
CUT1  20 120 30
      SPEED PRESS OFFSET
FUNC  TOOL  REMOTE
```

Important!

- The sheet could fall out if the sheet sensor is disabled, and the leading edge of the sheet is not detected with the head on top of the sheet sensor.

Two-point axis alignment

If a ruled sheet is set, align the horizontal and vertical axes with the appropriate lines on the sheet.
Correct the axial inclination (θ) by setting a compensation point in combination with the origin.

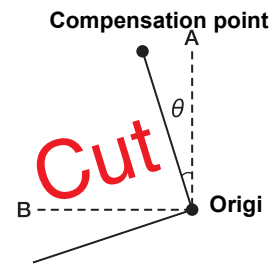

1 Press the **REMOTE** key to set to the local mode.

- Confirm in advance that even if you press the **REMOTE** key to enter the remote mode, the plotter does not perform cutting (plotting).

<LOCAL>		
CUT1	20	120 30
	SPEED	PRESS OFFSET
FUNC	TOOL	REMOTE

2 Set the Origin by pressing the jog key **▲**, **▼**, **◀** or **▶** to and press the **ENTER/HOLD** key.

3 Press the jog key **▲**, **▼**, **◀** or **▶** to enter the jog mode.

- Press either one of the jog keys, and you can enter the jog mode.

<ORIGIN SET>			mm
	0.0		0.0
X		Y	
SHEET	TOOL	FEED	

4 Press the **SHEET** key.

<AXIS CORRECT>			mm
	0.0		0.0
X		Y	
SHEET	TOOL	FEED	

5 Press the jog key **▲**, **▼**, **◀** or **▶** to set the compensation point.

- $\theta = -45$ to 45 degrees

6 Press the **ENTER/HOLD** key to decide the origin.

- The display is as shown on the right briefly, after which the plotter returns to the local mode.

** AXIS CORRECT **		
	$\theta = 15^\circ$	
X		Y
SHEET	TOOL	FEED



- When you clear the compensation point, move the clamp lever to the rear side to make the clamp OFF and perform sheet detection (👉 P.2-14) again.

Cutting area

Set the area in which the plotter performs cutting (plotting). The area that has a diagonal line extending from the origin to a given UL (upper left) point is the available cutting area. The cutting area setting will be cleared by performing sheet detection again.

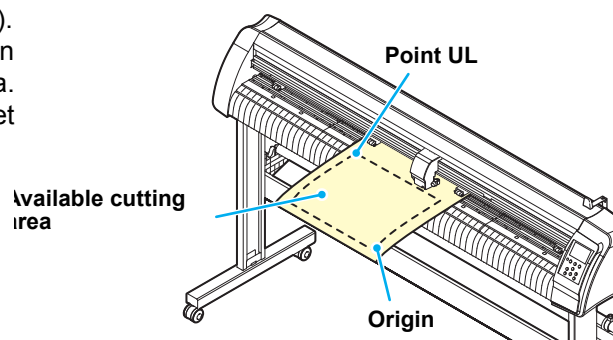

1

Press the **REMOTE** key to set to the local mode.

- Confirm in advance that even if you press the **REMOTE** key to enter the remote mode, the plotter does not perform cutting (plotting).

<LOCAL>		
CUT1	20	120 30
SPEED PRESS OFFSET		
FUNC	TOOL	REMOTE

2

Press the jog key , ,  or  to enter the jog mode.

- Press either one of the jog keys, and you can enter the jog mode.

<ORIGIN SET>			mm
0.0			0.0
X		Y	
SHEET	TOOL	FEED	

3

Press the **FEED** key.

<CUT AREA>			mm
0.0			50.0
X		Y	
SHEET	TOOL	FEED	

4

Press the jog key , ,  or  to set the point UL.

5

Press the **ENTER/HOLD** key to decide the point UL.

- The display is as shown on the right briefly, after which the plotter returns to the local mode.

** CUT AREA **			
0.0			30.0
X		Y	
SHEET	TOOL	FEED	

Important!

- Be sure to set the upper left point in the area located in the normal direction from the origin.
- Be sure to set the origin in the cutting area. If the origin is located outside the cutting area, the plotter will go into an error state.

Digitization operation

The coordinates of the plotted figure relative to the origin are displayed on the host computer. Upon receiving the digitization command (DP;) from the host computer, the plotter is ready for digitization operation.

To conduct digitization, install a sheet with patterns to select points on it.



- The digitization operation is available only with an application software that incorporates a digitization function. Refer to the instruction manual for the application software for how to use the digitization function.

1

Set the plotter in the remote mode and make it receive the digitization command from the host computer.

- The display will change as shown at right.

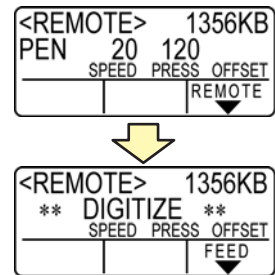

2

Move the pen with a jog key (▲) (▼) (◀) or (▶) until the pen tip reaches a given point of the pattern.

- The coordinates relative to the origin will be displayed.
- If you set the step to a smaller value using the jog step function, you may select a desired point with increased accuracy. (☞ P.3-78)

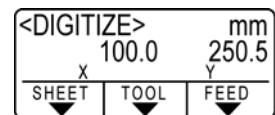

3

Press the (ENTER/HOLD) key.

- The plotter records the point of the pen head.
- The plotter receives the coordinate output command (OD;) from the host computer.

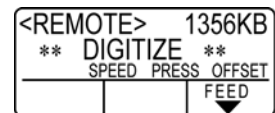

Set the distance compensation

When you cut the long data, the cut length may have difference depending on the sheet thickness. In addition, depending on the difference of the grid roller diameter, the moving amount of right and left of the sheet may have difference. Correct these differences.

You can select the distance correction from eight types (No. 1 to No. 8).

Find compensation value

Compensation value = Measured value of the OFF line - Input reference length

- Actual measured value of OFF line: 999.0 mm
- Entered standard length: 1000 mm
- $999.0 - 1000 = -1.0$ mm / (correction value)

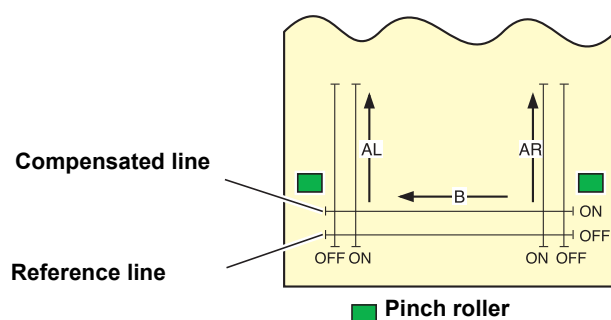

Setting value :

- Standard value
 - A direction: 500, 1000, 1500, 2000, 2500 (mm)
 - B direction(CG-60SRIII): 200, 400, 600 (mm)
 - B direction(CG-100SRIII/130SRIII): 200, 400, 600, 800, 1000 (mm)
- Correction value:
 - A direction: Standard length \pm 5% (0.1mm step)
 - B direction: Standard length \pm 5% (0.1mm step)
- Plotting offset: 0 to 300mm

Setting procedures

1

Mount the sheet. (☞ P.2-13)

- Set the sheet to plot the distance correction adjusting pattern.

2

Press the **FUNCTION** key in LOCAL mode.

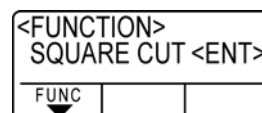

3

Press **▲** **▼** to select [DIST.COMP.].

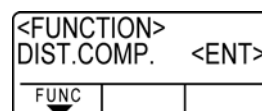

4

Press the **(ENTER/HOLD)** key.

- The correction value registered in AR (right side of front-back direction), AL (left side of front-back direction) and B (right-left direction) of No.1 are displayed.

<DISTANCE CORR.>		
No.1 AR=1.000000		
FUNC		

5

Pressing **(▲)** **(▼)**, select the distance correction number to register.

<DISTANCE CORR.>		
No.3 AR=1.00000		
FUNC		

6

Press the **(ENTER/HOLD)** key.

- The standard length (mm) that was corrected previous time is displayed.
- If you do not perform distance correction at all, the minimum standard length is displayed.
- When you change the length unit (mm/inch) from you corrected previous time, the right screen appears.

<DISTANCE CORR.>		
A= 500 B= 200		
FUNC		

<DISTANCE CORR.>		
A=----- B=-----		
FUNC		

7

Press **(▲)** **(▼)** to change the standard length of A direction (front-back direction).

- The standard length of A direction becomes standard length of AR (right side of front-back direction) and AL (left side of front-back direction).
- When you change the standard length, the distance correction value (AR, AL) corrected previous time is cleared.

<DISTANCE CORR.>		
A=1000 B= 200		
FUNC		

8

Press the **(ENTER/HOLD)** key to register the standard length of A direction.

- You can register it by the **(▶)** key.
- Moves to the standard length setting of B direction.

<DISTANCE CORR.>		
A=1000 B= 200		
FUNC		

9

Press **(▲)** **(▼)** to change the standard length of B direction (right-left direction).

- When you change the standard length, the distance correction value (B) corrected previous time is cleared.

10

Press the **(ENTER/HOLD)** key to register the standard length of B direction.

<DISTANCE CORR.>		
DRAW SHIFT= 0mm		
FUNC		

11

Press **(▲)** **(▼)** to specify the plotting position of the distance correction adjusting pattern.

- Offset all line segments (AR, AL, B) in the sheet.

DISTANCE CORR.>		
DRAW SHIFT= 20mm		
FUNC		

12

Press the **(ENTER/HOLD)** key.

- Plot the adjusting pattern.
- If a paper is not set, or, the paper size is too small and the standard length cannot be plotted, plotting is not performed. In such a case, when you press the **(ENTER/HOLD)** key, you can enter the correction value without plotting.

- 13** After plotting is completed, the current correction value is displayed.

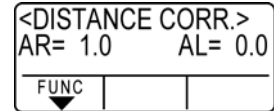

- 14** Actually measure OFF lines of AR, AL and B.

- Move the clamp lever to the rear side, remove the sheet and measure.

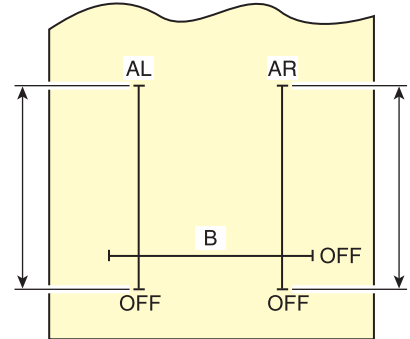

- 15** Perform the operations in Steps 2 to 13.

- As the sheet is not set, the correction entry screen is displayed without performing plotting.

- 16** If the measured value is different from the standard value, change the correction value with .

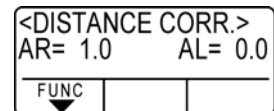

- 17** Press the key to register the correction value of AR direction.

- You can register it by the key.
- Moves to the standard length setting of AL direction.

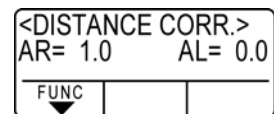

- 18** In the same way as the Step 14, enter the correction value of AL with .

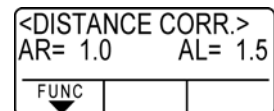

- 19** Press the key to register the correction value of AL direction.

- You can register it by the key.
- Moves to the standard length setting of B direction.

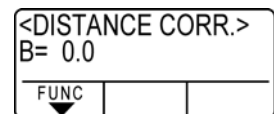

- 20** Change the correction value of B direction with .

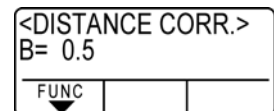

- 21** Press the key to register the correction value of B direction.

- When you press the key, the screen returns to step3.

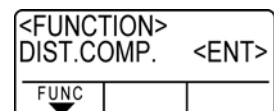

Perform Multiple Cuttings

This function performs cutting (plotting) for the received data on two or more sheets. (Maximum 999 cuttings)

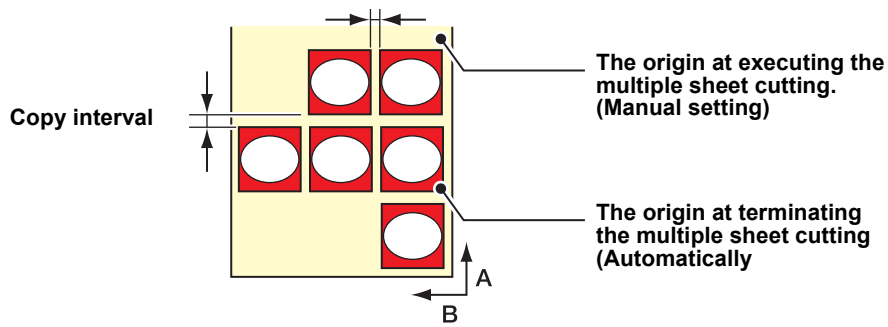

- You can perform multiple cuttings by specifying data saved in the receiving buffer of this device.
- The receiving buffer can save only one data.
- When a new data is received, the data that has been saved is overwritten by it. (You cannot perform multiple cuttings by specifying the data that was received before.)

1	Press the FUNCTION key in the local mode.	<FUNCTION> SQUARE CUT <ENT> <hr/> FUNC
2	Press the jog key ▲ or ▼ to select [No.COPIES].	<FUNCTION> No.COPIES <ENT> <hr/> FUNC TOOL REMOTE
3	Press the ENTER/HOLD key.	<No.COPIES> No.COPIES : 1 <hr/> FUNC TOOL REMOTE
4	Press the jog key ▲ or ▼ to select the number of cutting (1 to 999), and press the ENTER/HOLD key.	<No.COPIES> No.COPIES :10 <hr/> FUNC TOOL REMOTE ↓ <No.COPIES> INTERVAL :1mm <hr/> FUNC TOOL REMOTE
5	Press the jog key ▲ or ▼ to select the interval of figures to be cut (0 to 30mm), and press the ENTER/HOLD key.	<No.COPIES> ITNERVAL :10mm <hr/> FUNC TOOL REMOTE ↓ <FUNCTION> No.COPIES <ENT> <hr/> FUNC TOOL REMOTE

3 Useful Function

Important!

- If the multiple sheet cutting is executed immediately after cutting in the remote mode, cutting (plotting) will be overlapped. To avoid this trouble, be sure to set the new origin.
- While the plotter is executing the multiple sheet cutting, it ignores data sent from the computer.
- To send two or more pieces of data from the computer to the plotter, the data has to be sent while providing an interval of 5 seconds or more between any two pieces of data. If two pieces of data are sent from the computer to the plotter within 5 seconds, the two pieces of data will be subjected to the multiple sheet cutting. (This time can be changed in the close time setting.  P.3-53)
- During setting of the two-point axis alignment, if the origin updated inside the plotter fails to fall within the available cutting area, the plotter will not perform cutting for the data.
- The plotter performs cutting for divided cutting data by the specified number of sheets without dividing the data. If any error is displayed, refer to [Chapter 4] .
- If there is the origin renewal command in cutting data, you cannot perform [No. COPIES].
- When you use FineCut, the default value of Origin Renewal is "ON". If you perform [No. COPIES], uncheck the checkbox. (Refer to FineCut OPERATION MANUAL Chapter5 "Setting Head Position after Plotting")
- When the origin mode is set to "Center", the cutting result may not be as intended. When cutting multiple sheets, we recommend setting the origin mode to "Bottom right".

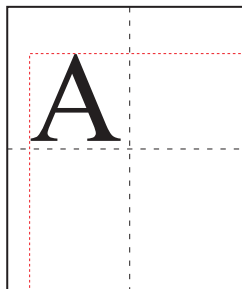

When the origin is set to center, the data size range is the diagonal size of the minimum cut range area to the maximum data range (shown by red dotted lines); therefore, data as shown in the illustration will create wide margins.

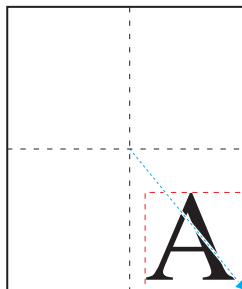

When the origin is set to center, and if you are using an application such as FineCut, the data is output to the minus position coordinate from the origin, considering the position of the origin. Data is copied with minus offset (shown with blue-dotted line); therefore by renewing the origin at the time of cutting multiple sheets, the media is cut at the position away from the position of the origin.

The first sheet is overlapped and cut, but when the origin is set to center, you need to cut multiple sheets without renewing the origin.

Cut Out Data with Registration Mark

Create registration marks on an output image that you want to make a seal, and then the plotter detects them to cut it out.

There are following two types of registration marks.

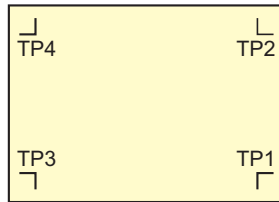

Registration mark: Type 1

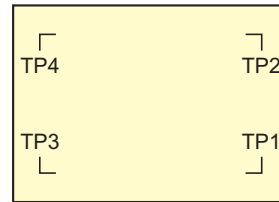

Registration mark: Type 2



- Use the TP4 when performing trapezium compensation to correct the uneven sheet feeding rate caused by the difference in the diameter between the right and left grit rollers. If the trapezium compensation is to be omitted, there is no need to set the TP4. In that case, however, cutting distortion will increase.

The Flow of Cutting out the Registered Data

Add registration marks on the image that you want to make a seal and others, and print it on a sheet.

There are some conditions for creating the registration marks. See pages P.3-12 through P.3-16.

Set the printed sheet in CG-SRIII series.

Set it referring to P.2-13.

Send the cut-target image from the computer for cutting.

In case it is not successfully cut,

- Confirm the reaction of registration mark sensor.
- Confirm the position of the Light Pointer.
- Adjust the sensitivity of the registration mark sensor.

Enter the registration mark detection mode

1

Press the **END** key in the local mode.

- It turns out to be a registration mark detection mode.



- When the registration detection is set to OFF, it doesn't enter into the registration mode. (☞ P.3-16)
- While various functions are under setting, data entry may be cancelled and the plotter may go back to the previous setting item.

Precautions in inputting data with registration marks

There are some limitations on preparing data with registration marks. In order to make full use of this function, read the following instructions carefully and prepare data with registration marks properly.



- The registration mark described here is intended to detect the sheet inclination and the lengths along the A and B axes. It is not a mark for trimming.

Size of the registration marks

The registration mark length shall be about more than ten times the line width.

In addition, for the length of a side of the registration mark against the data, refer to "The size of, and the distance between, registration marks" (P.3-14).

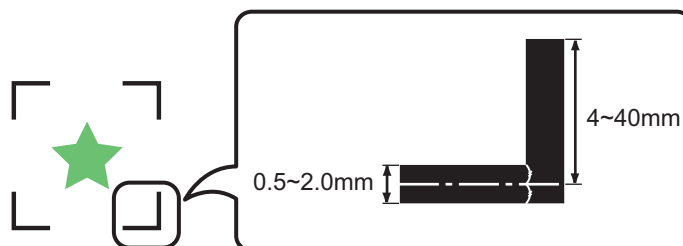

The area where registration marks and designs can be arranged

- The TP1 starting position must be 20 mm or more away from the leading edge of the sheet.
- The TP2 end position must be 45 mm or more away from the tail end of the sheet.

Mark Form : Type 1

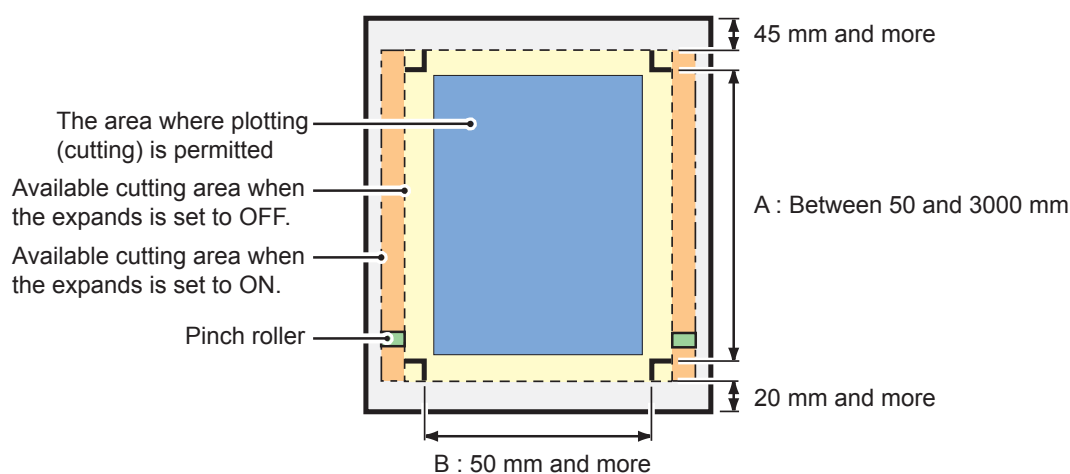

Mark Form : Type 2

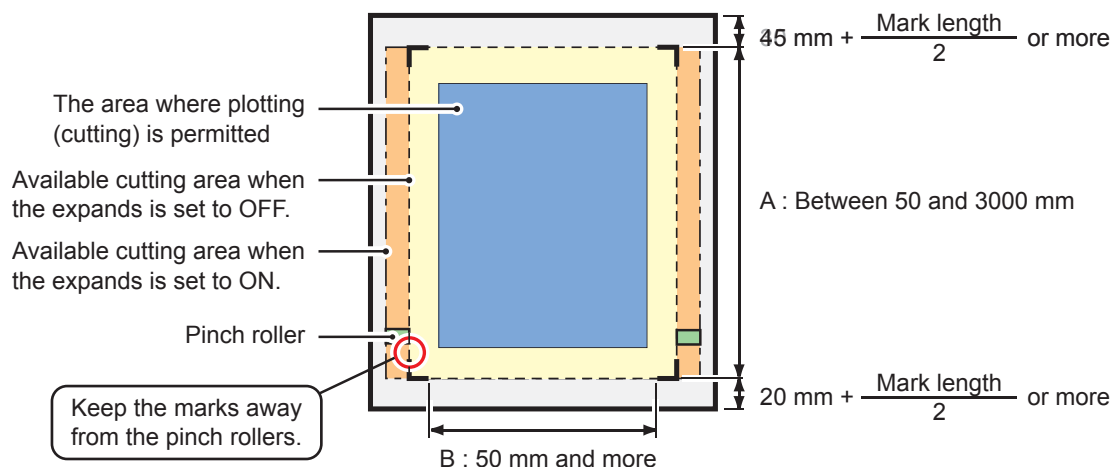

No-plotting area around the registration marks

An area around a registration mark (from the mark origin to the mark size area) is a non-plotting area. There must be no data plotted or stain in this area; otherwise, a wrong origin may be detected or a mark read error can occur.

Important!

- If a wrong mark origin is detected, the cutting will be performed in a wrong area.

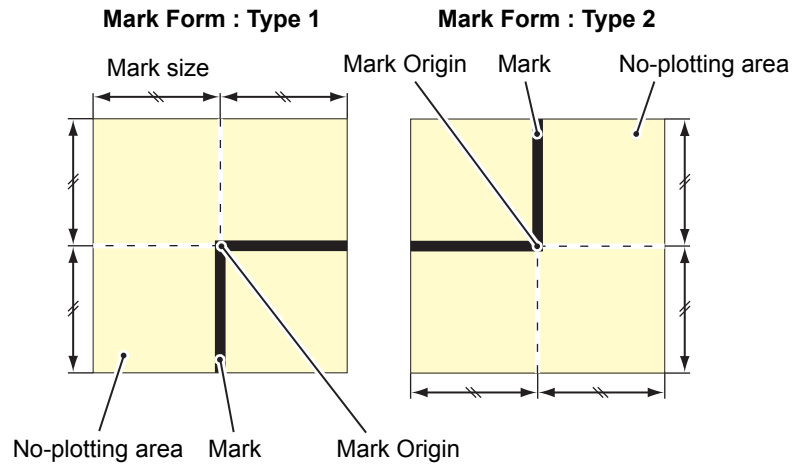

Example of cause of wrong detection 1

There is a line outside the registration marks

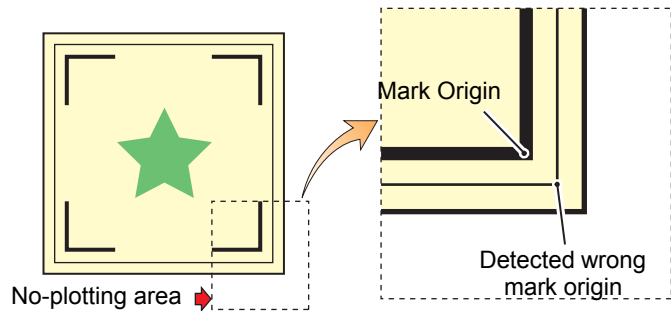

Example of cause of wrong detection 2

The distance between registration marks (TP2 and TP1 or TP4 and TP2) is smaller than the mark length (for Type 2)

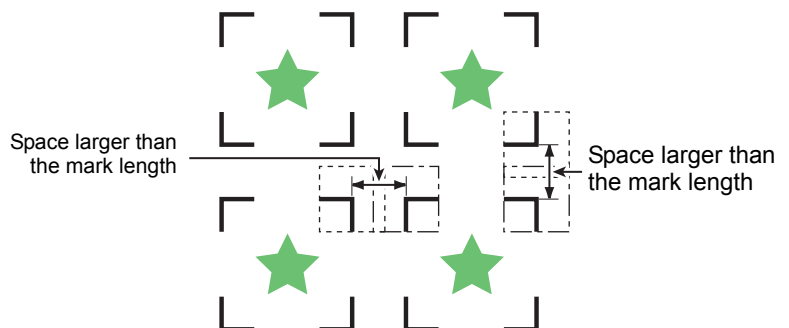

The size of, and the distance between, registration marks

The size (B) of a registration mark suited for the distance (A) between the marks is as shown below. If the mark size (B) is too small relative to the distance (A), the marks may not be detected correctly. Be sure to prepare the registration marks with an appropriate size.

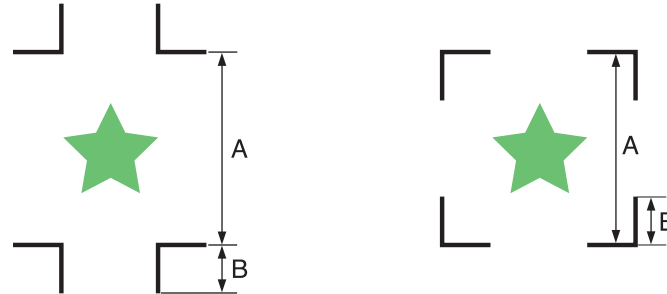

A	200 max.	500 max.	1000 max.	2000 max.	2001 min.
B	4 min.	8 min.	15 min.	25 min.	35 to 40

(mm)

Distance between registration marks for copied designs

For Type 1 registration marks, the distance between the marks must be not shorter than two times the mark length and not longer than 1000 mm. For Type 2 registration marks, the distance between the marks must be not shorter than the mark length and not longer than 1000 mm.

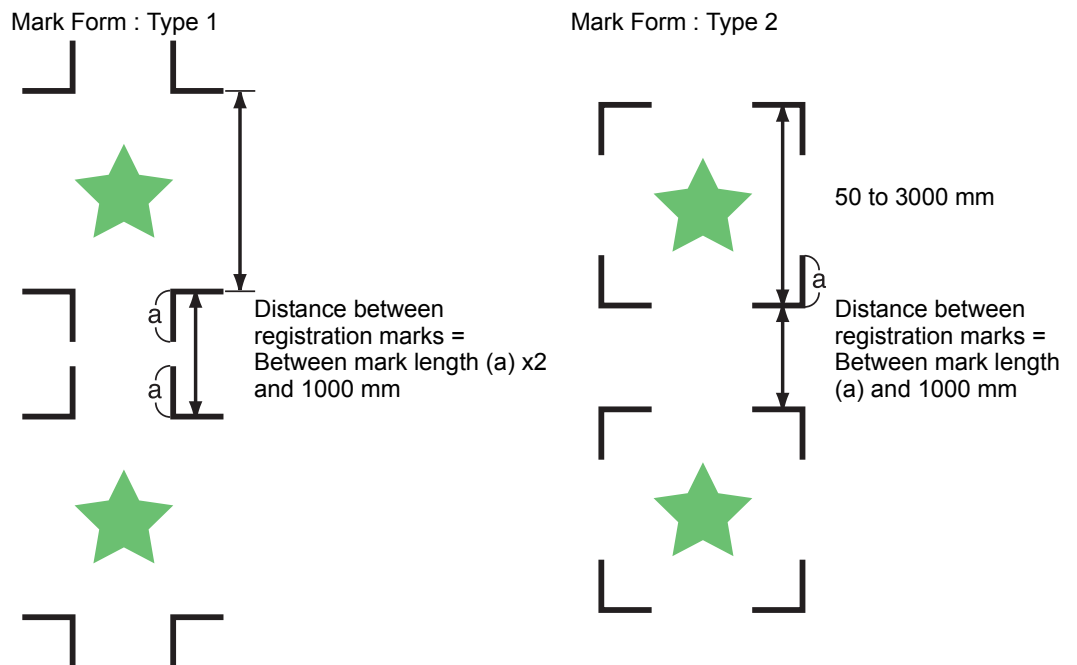

Recommended size of the area defined with a set of four registration marks

It is recommended that the size of the area defined with a set of four registration marks is in the range of A4 size (210 mm x 297 mm) to A3 size (297 mm x 420 mm). If you follow this recommendation, you can minimize wasteful spaces and arrange the designs efficiently.

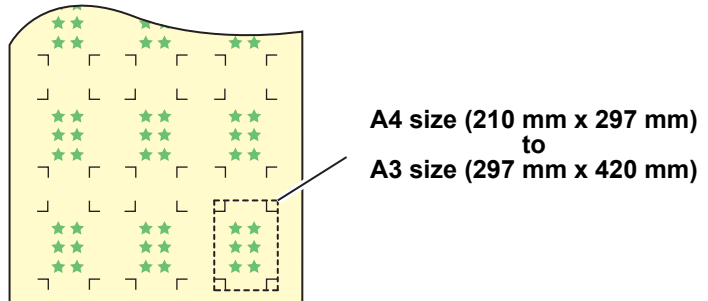

In case of perform printing a registration mark continuously

When perform printing a registration mark continuously, set the one side of the registration mark size to 8mm. In case 8mm or shorter registration mark recognized continuously, may cause the glitches on the main unit.

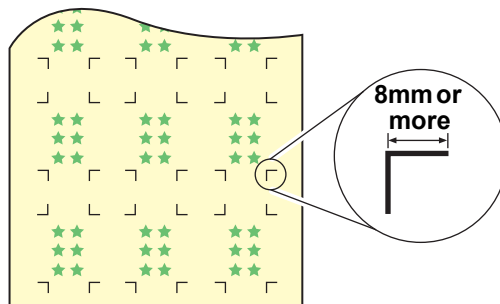

Color of mark

The mark must be printed in black against the white background. The registration mark will not be detected correctly if the background is not white or the mark is not black.

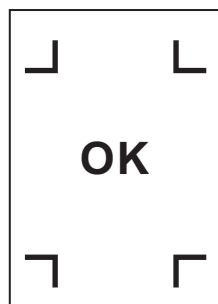

Mark blurred

If the mark is blurred, a wrong mark origin can be detected, thus resulting in deviated cutting.



Precautions on registration mark detection

Observe the following precautions on registration mark detection.

- To ensure that the distance between registration marks is equal to the cutting length, input the distance between the printed marks found by the mark detecting function. (DIST.REVI P.3-18)
In this case, scale compensation between the registration marks overrides distance compensation. After that, if you change the distance compensation value, the scale compensation between the registration marks will be invalid.
- When you retry sheet detection, sheet inclination compensation, scale compensation between registration marks, and the position of the origin are cleared.
- Once the plotter detects marks, it will set the origin at the location of TP1.
You can change the position of the origin to a different location using jog keys ; the origin at the new location supersedes the origin at TP1.
- Locate registration marks so that the line connecting the corners of four marks forms a rectangle.
Registration marks arranged unevenly can result in deviated cutting.
- Automatically disabled if the rotation function is specified.

Set for Detecting the Registration Marks

When you want to cut the data with registration marks, you must set the following without fail.

1 Press the **FUNCTION** key in the local mode.

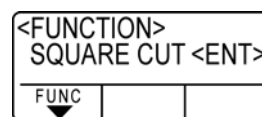

2 Press the jog key or to select [SET UP] .

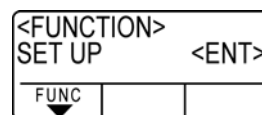

3 Press the **ENTER/HOLD** key.

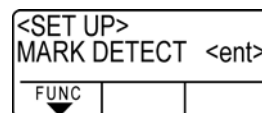

4 Press the **ENTER/HOLD** key.

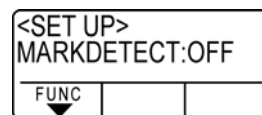

5 Press the jog key  or  to select [Number of detected registration marks].

- Set values: OFF, 1pt, 2ptA, 2pt B, 3pt, and 4pt

<SET UP>		
MARKDETECT:2ptA		
FUNC		
▼		

6 Press the  key.

- In case you selected “OFF” in Step 5, proceed to Step 11.

<SET UP>		
DETECTMODE:FAST		
FUNC		
▼		

7 Press the jog key  or  to select the following items.

- The following items are provided for the setting of registration mark detection:
Scale compensation, registration mark size, offset A, offset B, form of registration mark, number of continuous cutting in direction A, number of continuous cutting in direction B, high speed limit, skew check, detect mode and sensor level
- See pages P.3-18 through P.3-20 for the contents of each setting item.

8 Press the  key.

9 Press the jog key  or  to select the set values.

- See pages P.3-18 through P.3-20 for the contents of each setting item.

10 Press the  key to confirm the value.

11 When you want to terminate this procedure, press the  key twice.

Setting Items

Setting the Number of Registration Mark Detection

The higher the number of detected points, the higher the cutting accuracy.

Important! • Select “1pt” when using FineCut.

Setting	Description
OFF	Select this setting for cutting a normal sheet, not for cutting the outline.
1pt	Detects the TP1. Sets only the origin.
2pt A	Detects the two registration marks TP1 and TP2. Performs the skew compensation and the scale compensation in the sheet feeding direction.
2pt B	Detects the two registration marks TP1 and TP3. Performs the skew correction and the scale compensation in the width direction.
3pt	Detects the three registration marks TP1, TP2 and TP3. Performs the skew compensation and the scale compensation in the sheet feeding and the width direction.
4pt	Detects the four registration marks TP1, TP2, TP3 and TP4. Performs the skew compensation, the scale compensation in both directions, and the trapezium compensation.

DIST.REVI

Select “OFF” when using FineCut.

Setting	Description
OFF	The plotter will not perform any scale compensation.
BEFOR	With this setting, enter the scale compensation values and the trapezium compensation ^{*1} value before executing the registration mark detection. (☞ P.3-21 , ☞ P.3-24) Since the distance between registration marks is entered beforehand, rapid movement is expected when detecting.
AFTER	With this setting, enter the scale compensation values and the trapezium compensation value ^{*1} after executing the registration mark detection. (☞ P.3-21 , ☞ P.3-24) Since there is an understanding of the distance between marks, setting values can be input rapidly. The AFTER setting will take less time than the BEFORE setting.

*1. The diameter difference between the grit rollers may cause a significant difference in the sheet feeding distance between the right side and the left side. The trapezium compensation function correct this difference in sheet feeding between the right side and the left side.

Size

Setting	Description
4~40mm	Set the length of one side of the registration mark. When the printed mark's horizontal and vertical lengths differ from each other, set the same value as the shorter length.

Length of one side



Offset A, Offset B

Setting	Description
± 40.00mm	<p>Generally the origin will be set at the position shown below. However, depending on your application and the work to be cut, the cutting position may be misaligned to the same direction. In this case, the location of the origin can be corrected.</p> <div style="display: flex; justify-content: space-around;"> <div style="text-align: center;"> <p>Mark: Type 1</p> </div> <div style="text-align: center;"> <p>Mark: Type 2</p> </div> </div> <p>If the origin is located out of the available cutting area, "ERR37 MARK ORG" will be displayed. In this case, write the registration marks in the area closer to the center of the sheet.</p>

MARK FORM

Setting	Description
<p>TYPE1 </p> <p>TYPE2 </p>	<p>Select either one of the following types of registration marks.</p> <div style="display: flex; justify-content: space-around;"> <div style="text-align: center;"> <p>Mark: TYPE1</p> </div> <div style="text-align: center;"> <p>Mark: TYPE2</p> </div> </div>

COPIES A (UP), COPIES B (LEFT)

Setting	Description
<p>1~9999 (COPIES A)</p> <p>1~99 (COPIES B)</p>	<p>Effective when the same pattern is multi-printed at regular intervals. Cuts automatically the preset number of sheets while detecting registration marks consecutively based on the first data.</p> <div style="display: flex;"> <div style="flex: 1;"> </div> <div style="flex: 1;"> <p>For leaf sheets (cut sheets), the value of [COPIES A] is used as the number of copies.</p> <p>When the number of copies can be set on the application software, like on the supplied FineCut, set the value to [1].</p> <p>3x3 copies</p> </div> </div>

SPD LIMIT

Setting	Description
0~60cm/s	<p>Set a speed limit for rapid moving in continuous copying. During rapid moving, mark detection may not be performed correctly if a slippery sheet is used. In such a case, set a speed limit. If no speed limit is required, set the value to "0".</p>

SKEW CHECK

Setting	Description
OFF, 1~99mm	<p>Set the allowable range of the sheet feeding error when performing continuous copy. During continuous copying on a roll sheet, copies may be misaligned little by little because of sheet skewing. If the error in the B-axis coordinate of the TP1 mark has exceeded the allowable range, cutting operation is temporarily stopped.</p> <p>Press the ENTER/HOLD key after correcting the sheet feeding error. Then the plotter waits for mark detection.</p> <p>Move the light pointer to the position shown below with jog keys and press the ENTER/HOLD key. Then the light pointer starts mark detection. If skew check is to be omitted, set the value to "0".</p> <div style="text-align: center;"> <p>Mark: TYPE1 Mark: TYPE2</p> <p>Reference mark 1 Reference mark 2 (TP1)</p> <p>(TP1) (TP1)</p> <p>Starting point for mark detection</p> </div>

DETECT MODE

Setting	Description
FAST	The position is determined by scanning the registration mark segment back and forth once. Time required for detection is short, however, the accuracy becomes lower a little.
PREC	After scanning the registration mark segment back and forth once, measures the position without fail by scanning the segment included its outside again. Time required for detection becomes slightly longer.

SENSOR LEVEL

Setting	Description
1 ~ 7	The bigger the numerical value is, the higher the sensitivity of the registration mark sensor becomes. If it detects the registration mark by mistake, lower the sensitivity. Generally, use it with the setting value of "4".

MARK FILL UP

Setting	Description
ON, OFF	Specify the setting as "ON" when using the "Fill around the register mark" function of FineCut to detect the printed registration mark. Create using a registration mark size of 10 mm or more when filling in around the registration mark.

Reset the Setting of Registration Mark Detection

In case the plotter detects the sheet that has no printing of registration marks and displays [SEARCH START POS] you must set the registration mark detection to "OFF."
Then, the registration mark detection becomes rendered ineffective.

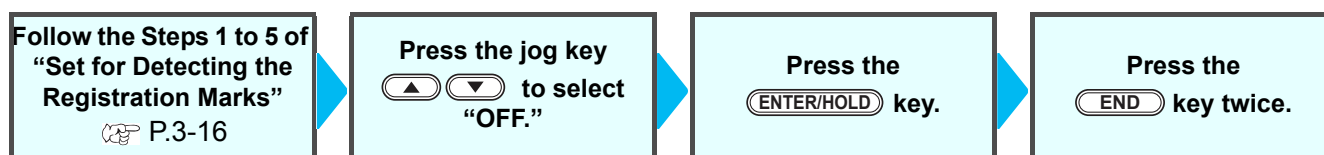

Method of detecting registration marks

Registration marks are detected in two different ways; full-automatic detection and semi-automatic detection. Use the semi-automatic function when the TP1 is not located at the bottom right of the sheet, or when the supplied FineCut is to be used as the cutting software.

- Important!**
- If the sheet is curled, straighten it.
 - When using a cutting software having no mark function, use a sheet which has neither stains nor images in the area (A) located between TP1 and TP2 and in the area (B) located between TP1 and TP3.

Check sheet skew with a light pointer

Move down the clamp lever to the front and then the Light Pointer is turned lit. You can manually move the carriage to the left and right.

Move down the clamp lever to the front, and manually move the carriage between the registrations TP1 and TP3. Then you can confirm the sheet inclination by the move line of Light Pointer. Align to the move line and adjust the sheet inclination.

- Important!**
- If no operation is performed for five minutes, the light pointer will automatically go out.

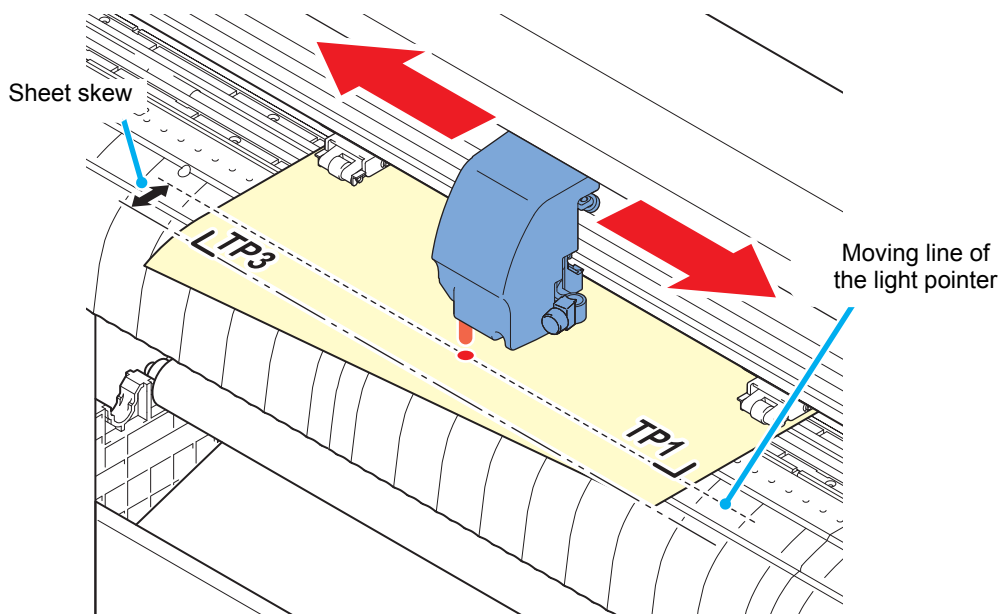

Full-automatic detection of marks

Use this function to correct the error in the detected length between registration marks as compared with the printed length between registration marks. For this purpose, measure the length A and B on the data beforehand. Measure the length between the registration marks.

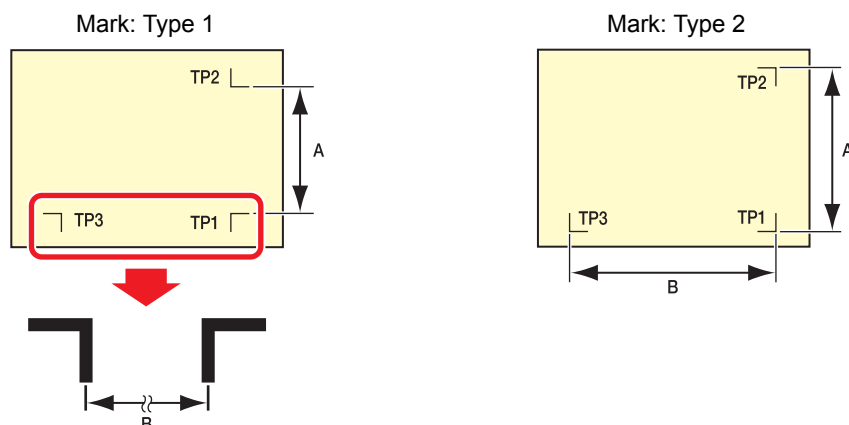

Detecting procedure ([DIST.REVI.] Setting value is "BEFOR")

Important!

- Be sure to set the sheet in the rear.

1 Measure the lengths **A** and **B** on the data to be output.

2 Place TP1 at a location shown at right.

- If it is impossible to place the registration mark TP1 at the location shown in the sketch, follow the procedure for "Semi-automatic registration mark detection".

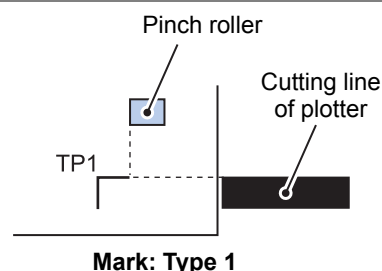

Mark: Type 1

3 You must take care to tighten the sheet, and move down the clamp lever to the front.

- Then the pinch rollers will retain the sheet.

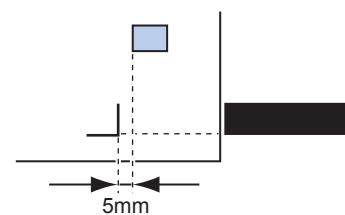

Mark: Type 2

4 Press the **ENTER/HOLD** key.

- The scale compensation display appears after detecting only the sheet width. (The right figure shows the 4-point detection display as an example.)
- In case [ROLL. SELECT] is set [ON] (☞ P.3-18), select the number of pinch roller to use.

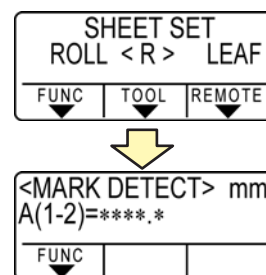

5 Set with the jog key **▲** or **▼**.

- Press the **ENTER/HOLD** key. And the plotter moves to the next scale compensation setting.
- If [MARK DETECT] is set to [2ptA], the display for inputting the B length will not appear.
- If [MARK DETECT] is set to [1pt], the scale compensation setting display will not appear but the origin point will be displayed. (Step 7)

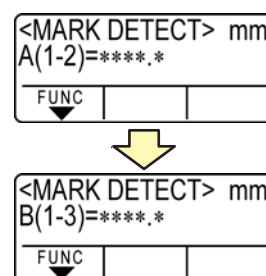

6 Press the **ENTER/HOLD** key after completing the settings.

- The registration mark detection will be started.
- In case the plotter cannot detect any registration marks, it displays "Error C36 in the registration mark detection" on the display. Set the sheet again.

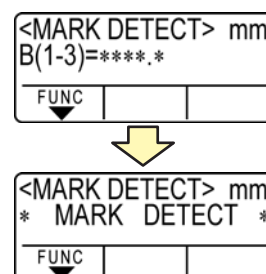

7 Set the origin.

- After the detection of the registration marks, the display will show the available cutting area and then return to local mode.

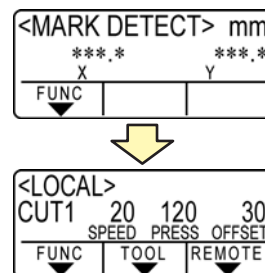

Detecting procedure ([DIST.REVI.] Setting value is "AFTER")

Important!

- For the number of registration marks detected in the Step 2, refer to "Setting the Number of Registration Mark Detection" (P.3-18).
- Be sure to set the sheet in the rear.

1 Follow steps 1 to 3 of "Detecting procedure ([DIST.REVI.] Setting value is "BEFOR")" (P.3-22)

2 Press the **ENTER/HOLD** key.

- In case [ROLL. SELECT] is set [ON] (P.3-18), select the number of pinch roller to use. The registration mark detection will be started after detecting only the sheet width.
- After only the sheet width has been detected, registration mark detection starts.
- In case the plotter cannot detect any registration marks, it displays "Error C36 in the registration mark detection" on the display. Set the sheet again.

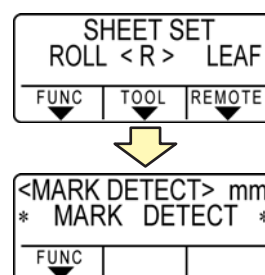

3 After the detection of the registration marks, the scale compensation display appears.

- The right figure shows the 4-point detection display as an example.
- If there is a difference between the actually measured value and the detected length, make setting with the jog key (▲) or (▼).
- Press the **ENTER/HOLD** key to change the display to the next scale compensation setting.
- If [DIST. REVI.] is set to [OFF], the display for scale compensation setting will not appear.
- If [MARK DETECT] is set to [2ptA], the display for inputting the B length will not appear.
- If [MARK DETECT] is set to [1pt], the display for scale compensation will not appear. Proceed to Step 4 and set the origin.

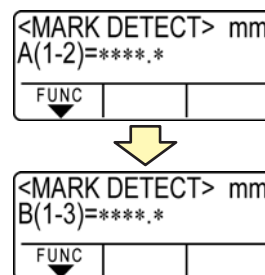

4

Press the **ENTER/HOLD** key after completing the settings.

- Set the origin.
- The display will show the available cutting area and then return to local mode.

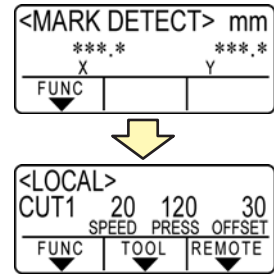

Semi-automatic detection of registration marks

When TP1 cannot be located at the position where it can be detected full-automatically or when no registration mark can be detected full-automatically, perform registration mark detection semiautomatically.

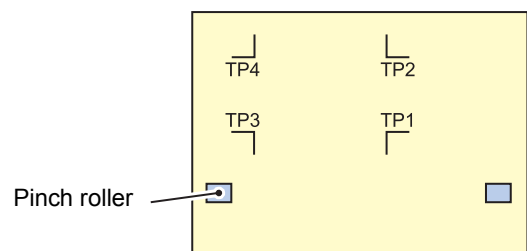

Detecting procedure ([DIST.REVI.] Setting value is "BEFOR")

1

Load the sheet Load the sheet and move down the clamp lever to the front.

- Then the pinch rollers will retain the sheet.

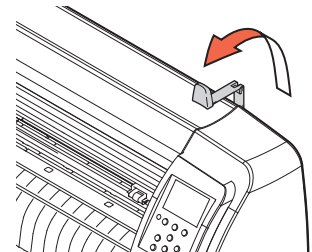
**2**

Perform the sheet detection by pressing the jog key or . (Set the sheet in the rear.)

- In case [ROLL. SELECT] is set [ON] (P.3-18), select the number of pinch roller to use.
- Once the sheet is detected, the display indicates that the plotter is waiting for registration mark detection operation.

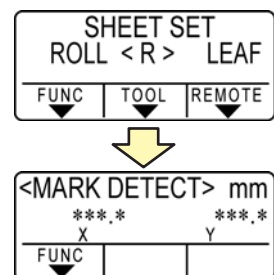

- When the sheet is set in the front, the positions of the TP1 to TP4 are viewed inverted as shown at right.

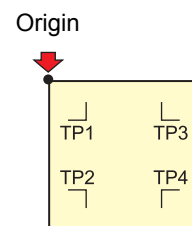

3 Move the Light Pointer into the area shown below by pressing the appropriate ones of the jog keys

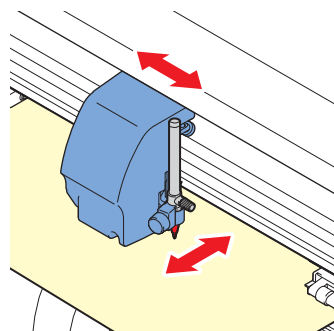
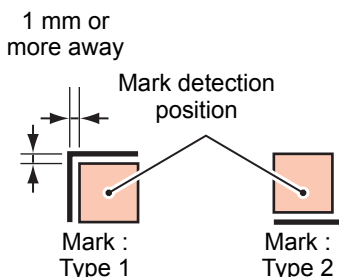

4 Press the **ENTER/HOLD** key.

- The scale compensation display appears. (The right figure shows the 4-point detection display as an example.)

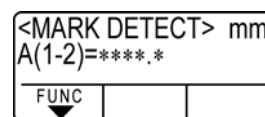

5 Make setting with the jog key **▲** or **▼**.

- Press the **ENTER/HOLD** key to change the display to the next scale compensation setting.
- If [DIST.REVI.] is set to [OFF], the display for scale compensation setting will not appear.
- If [MARK DETECT] its set to [2ptA], the display for inputting the B length will not appear.
- If [MARK DETECT] is set to [1pt], the scale compensation setting display will not appear but the origin point will be displayed.

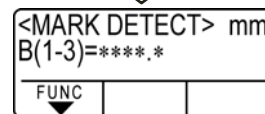
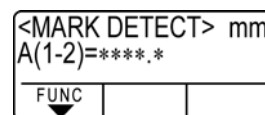

6 Press the **ENTER/HOLD** key after completing the settings.

- The plotter will start detecting the registration marks according to the settings of [MARK DETECT].
- See “Setting the Number of Registration Mark Detection” (P.3-18) for the number of registration marks.
- In case the plotter cannot detect any registration marks, it displays “Error C36 in the registration mark detection” on the display. Set the sheet again.

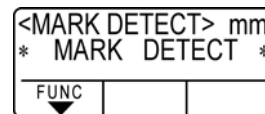
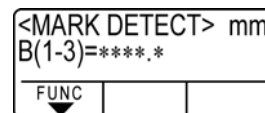

7 Set the origin.

- The display will show the available cutting area and then return to local mode.

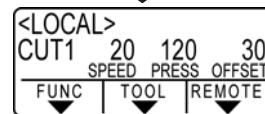
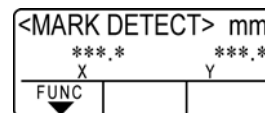

Detecting procedure ([DIST.REVI.] Setting value is “BEFOR”)

1 Follow steps 1 to 3 of “Detecting procedure ([DIST.REVI.] Setting value is “BEFOR”)” (P.3-24)

2 Press the **ENTER/HOLD** key.

- The plotter will start detecting the registration marks according to the settings of [MARK DETECT].
- See “Setting the Number of Registration Mark Detection” (P.3-18) for the number of registration marks.
- In case the plotter cannot detect any registration marks, it displays “Error C36 in the registration mark detection” on the display. Set the sheet again.

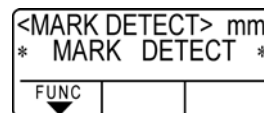

3 After the detection of the registration marks, the scale compensation display appears.

- The right figure shows the 4-point detection display as an example.
- If there is a difference between the actually measured value and the detected length, make setting with the jog key (▲) or (▼).
- Press the **ENTER/HOLD** key to change the display to the next scale compensation setting.
- If [DIST.REVI.] is set to [OFF], the display for scale compensation setting will not appear.
- If [MARK DETECT] is set to [2ptA], the display for inputting the B length will not appear.
- If [MARK DETECT] is set to [1pt], the scale compensation setting display will not appear but the origin point will be displayed.

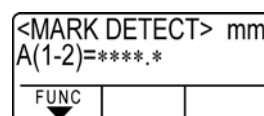

4 Press the **ENTER/HOLD** key after completing the settings.

- Set the origin.
- The display will show the available cutting area and then return to local mode.

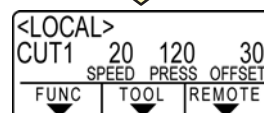
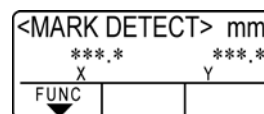

Detect a registration mark automatically after the sheet is detected

Set the automatic registration mark search function performed after the sheet is detected.

If both of the registration mark detection and the registration mark search is valid, the function will search the registration mark automatically after the sheet is detected.

From the original point after detecting the sheet, it scans the set scan width back and forth at half intervals of the registration mark size. Then, when it finds a segment, a point or a printed material, the registration mark detection will be performed.

If the vertical line and the horizontal line are detected properly, it is recognized as a registration mark and the original point setting will be performed.

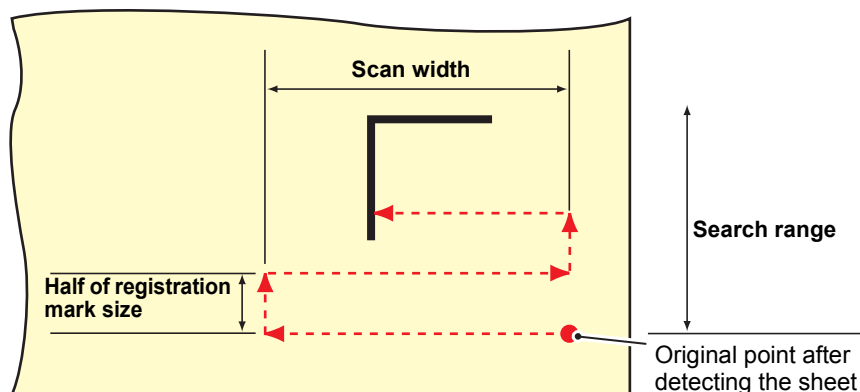

- 1 Press the **FUNCTION** key in the local mode.

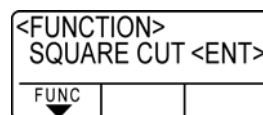

- 2 Press the jog key **▲** or **▼** to select [SET UP] .

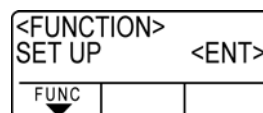

- 3 Press the **ENTER/HOLD** key.

- 4 Press the jog key **▲** or **▼** to select [SEARCH MARK] .

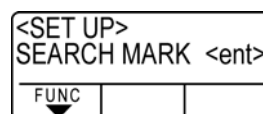

- 5 Press the **ENTER/HOLD** key.

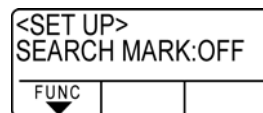

- 6 Press the jog key **▲** or **▼** to select "ON".

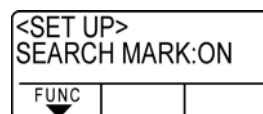

- 7 Press the **ENTER/HOLD** key.

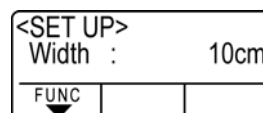

8**Press  or  key to select the scan width.**

• Set values: 10 to 30cm

<SET UP>		
Width :	20cm	
FUNC		
▼		

9**Press the  key.**

<SET UP>		
Range :	10cm	
FUNC		
▼		

10**Press  or  key to select the search range.**

• Set values: 10 to 50cm

<SET UP>		
Range :	30cm	
FUNC		
▼		

11**Press the  key.****12****Press the  key twice for terminating this function.****Important!**

- If it is not recognized as a registration mark or there is no response even if the function scans the area set for search, the message indicating the search failure will be displayed in a certain time. Then, it will return to the original point and the mode will move to the normal semi-automatic registration mark detection mode.

<MARK DETECT> mm		
SEARCH FAILED		
FUNC		
▼		

Confirm the following when failed in cutting correctly.

Check the sensor for the registration mark detection

Prepare the sheet on which the registration mark is printed.

Important!

- If you move the head and sheet manually, you cannot perform the right response check. Be sure to perform it via the following operations.
- For conditions of already printed registration mark, refer to “Precautions in inputting data with registration marks” (☞ P.3-12).
- The setting values are kept in memory even when the power is turned off.
- The settings performed here for shape of the registration mark and length of the registration mark are reflected in the settings of “MARK DETECT”. (☞ P.3-12)
- The detection speed selected here will be used in the registration mark detection operations that are executed from here on.
- The pointer offset value selected by this operation is not initialized by SETUP RESET operation.
- Set the buzzer sound to “ON”. (☞ P.3-77) The registration mark detection sound is not made if the buzzer sound is set to OFF.

1

Make sure that the plotter is in local mode.

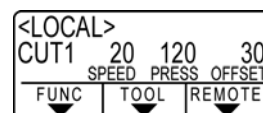

2

Enter the jog mode by pressing the jog key or .

3

Move the tip of the pen to the registration mark detection position by pressing the appropriate ones of the jog keys and .

- Perform registration mark detection at a position 1mm or more away from the registration mark.

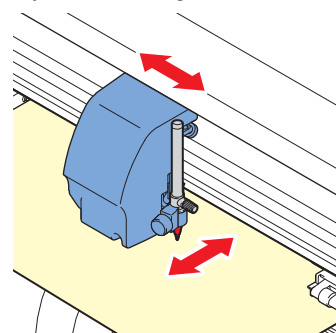
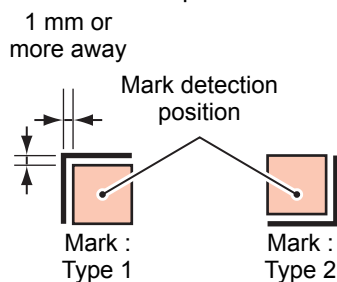

4

Press the key to terminate the jog mode.

- The plotter returns to the local mode.

5

Press the key.

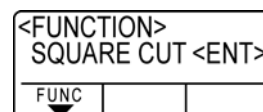

3

Useful Function

6

Select [MARK sensor] by pressing the jog key  or  .

<FUNCTION>		
MARK SENSOR<ENT>		
FUNC		
▼		

7

Press the  key.

<MARK SENSOR>		
SENSOR CHECK<ent>		
FUNC		
▼		

8

Press the  key after confirming [SENSOR CHK] is displayed.

9

Select the length of the registration mark and shape of the registration mark detection.

- For details on setting the [SIZE] and [FORM], refer to the [MARK DETECT] setting procedure. ( P.3-12)

<SENSOR CHECK>		
SIZE:	10mm	
FUNC		
▼		

<SENSOR CHECK>		
FORM	:Type1 	
FUNC		
▼		

10

Perform registration mark detection with the jog key  . (Next page)

Detect operation

1 Scan in the B direction (plus direction) to detect the line.

- The buzzer sounds when the line is detected. If the line is not detected, the buzzer does not sound.

2 Scan in the B direction (minus direction) to detect the line.

3 Scan in the A direction (plus direction) to detect the line.

4 Scan in the A direction (minus direction) to detect the line.

5 Follow the Steps 1 to 4, and confirm if the buzzer sounds 4 times.

- When the detection behavior completes successfully, the buzzer sounds 4 times.
- If the buzzer does not sound, contact our sales office after checking the registration mark condition.

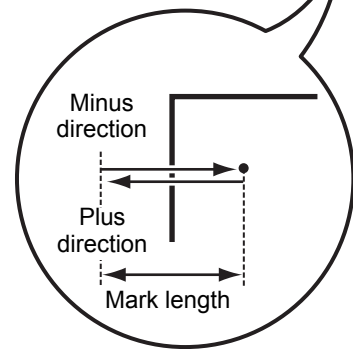
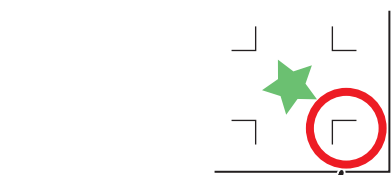

Scan in the A direction

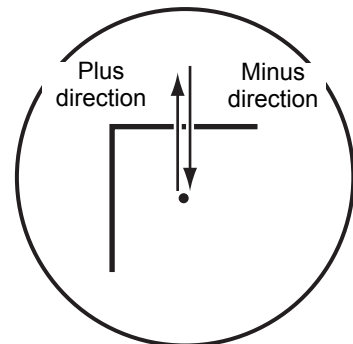

Scan in the B direction

Correct the light pointer position

If the plotter fails to recognize any registration mark properly, the possible cause is an error in the positional relationship between the MARK sensor and the light pointer. In this case, adjust the position of the light pointer.

1 Install a cutter in the tool holder.

2 Load the copy paper.

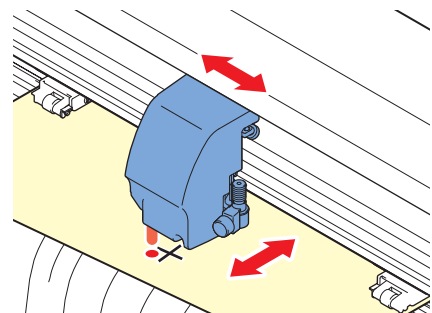

3

Confirm that the plotter is in the local mode.

<LOCAL>			
CUT1	20	120	30
SPEED PRESS OFFSET			
FUNC	TOOL	REMOTE	
▼	▼	▼	

4

Press the **FUNCTION** key.

<FUNCTION>		
SQUARE CUT <ENT>		
FUNC		
▼		

5

Select [MARK SENSOR] by pressing the jog key  or .

<FUNCTION>		
MARK SENSOR<ENT>		
FUNC		
▼		

6

Press the **ENTER/HOLD** key.

<MARK SENSOR>		
SENSOR CHECK<ent>		
FUNC		
▼		

7

Select [POINTER OFS] by pressing the jog key  or .

<MARK SENSOR>		
POINTER OFS <ent>		
FUNC		
▼		

8

Press the **ENTER/HOLD** key.

- A 10 mm by 10 mm cross pattern will be cutted.
- The light pointer turns on and moves to the center of the cross pattern.

<LED POINTER>		
A= 0.0 B= 0.0		
FUNC		
▼		

9

By pressing the jog keys , ,  and , adjust the light pointer position so that the center of the light pointer is in alignment with the center of the cross pattern.

10

Press the **ENTER/HOLD** key.

- The plotter will return to the local mode after registering the compensation value.

<LOCAL>			
CUT1	20	120	30
SPEED PRESS OFFSET			
FUNC	TOOL	REMOTE	
▼	▼	▼	

Important!

- The value registered in the [POINTER OFS] is not initialized even by executing the [SETUP RESET].

Alignment of MARK SENSOR

The offset value of the cutter and the mark sensor can be adjusted.
Set the sheet on which the register mark is printed.

1 Install a cutter in the tool holder.

2 Confirm that the plotter is in the local mode.

<LOCAL>			
CUT1	20	120	30
	SPEED PRESS		OFFSET
▼	▼	▼	▼
FUNC	TOOL	REMOTE	

3 Press the **FUNCTION** key.

<FUNCTION>		
SQUARE CUT <ENT>		
▼		
FUNC		

4 Select [MARK SENSOR] by pressing the jog key  or .

<FUNCTION>		
MARK SENSOR <ENT>		
▼		
FUNC		

5 Press the **ENTER/HOLD** key.

<MARK SENSOR>		
SENSOR CHECK <ent>		
▼		
FUNC		

6 Select [SENSOR OFS] by pressing the jog key  or .

<MARK SENSOR>		
SENSOR OFS <ent>		
▼		
FUNC		

7 Press the **ENTER/HOLD** key.



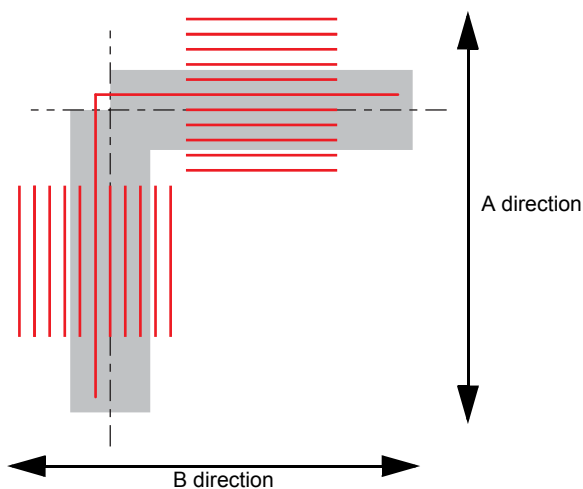

- The offset value of the cutter and the mark sensor can be adjusted.
- Set the sheet on which the register mark is printed.

<SENSOR OFS>		
A= 0.0 B= 0.0		
▼		
FUNC		



Misaligned by +0.2 mm from the center line of the register mark (---) in the A and the B direction.

8

Enter the corrected value (mm) by pressing the   for the A direction, or the   for the B direction.

- If misaligned by +0.2 mm, enter "-0.2".

<SENSOR OFS>		
A= -0.2 B= -0.2		
FUNC		
▼		

9

Press the  key.

- The plotter will return to the local mode after registering the compensation value.

<LOCAL>			
CUT1	20	120	30
	SPEED	PRESS	OFFSET
FUNC	TOOL	REMOTE	
▼	▼	▼	

Important!

- The setting values are kept in memory even when the power is turned off.
- The sensor offset value selected by this operation is not initialized by SETUP RESET operation.

Expand the cutting (plotting) area

You can reduce the dead space to expand cut (picture drawing) area (EXPANDS function).
The dead space becomes less by 10mm for the front and right/ left.

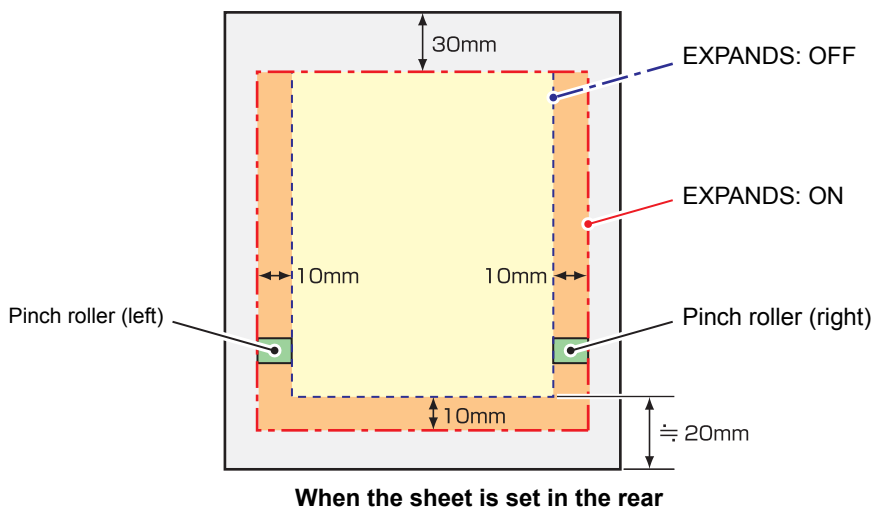

Set the EXPANDS function to ON.

- 1** Press the **FUNCTION** key in the local mode.

<FUNCTION> SQUARE CUT <ENT>
FUNC
▼

- 2** Press the jog key **▲** or **▼** key to select [SET UP].

<FUNCTION> SET UP <ENT>
FUNC
▼

- 3** Press the **ENTER/HOLD** key.

- 4** Press the jog key **▲** or **▼** key to select [EXPANDS].

<SET UP> EXPANDS <ent>
FUNC
▼

- 5** Press the **ENTER/HOLD** key.

<SET UP> EXPANDS : OFF
FUNC
▼

- 6** the jog keyPress **▲** or **▼** key to select "ON."

<SET UP> EXPANDS : ON
FUNC
▼

7 Press the **ENTER/HOLD** key.



8 Press the **END** key twice for terminating this function.

Important!

- When the Expand mode is set to ON, paper jam can occur if excessive pressure is applied to the sheet.
- If axis compensation is not performed, the cutter blade can run out of the sheet and may cause a paper jam. A cutter blade having run out of the sheet may damage itself or the plotter.
- The cutting quality of the areas that come in contact with the pinch rollers will be lowered.
- If a pinch roller comes in contact with a registration mark during its detection, the registration mark may not be detected properly.
- Once the Expand function is set after sheet detection, be sure to perform sheet detection again.

Set EXPANDS function to “OFF”.

Follow the Steps 1 to 5 of
“Set the EXPANDS
function to ON.”

Press the jog key
  to select
“OFF.”

Press the
ENTER/HOLD key.

Press the
END key twice.

Switch the cutting (plotting) direction

This function sets the location of origin and direction of the axes of coordinates according to the application software to be used. (ROTATION function)

Rotating function : OFF

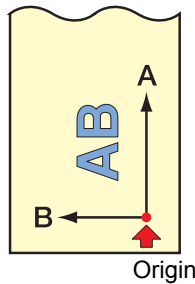

Rotating function : ON

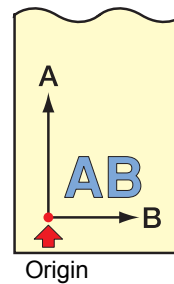

After the sheet detection, the carriage will stop at the origin.

Important!

- The setting values are kept in memory even when the power is turned off.
- Confirm that any data to be cut is not saved in the receiving buffer. If you change the set values, the contents of the receiving buffer are cleared completely.
- Rotation cannot be enabled if the register mark detection function is enabled. First turn off the register mark function before enabling rotation. (☞ P.3-16)
- The cut area settings are returned to the default settings if the rotation settings are changed.

The Setting of ROTATION.

1

Press the **[FUNCTION]** key in the local mode.

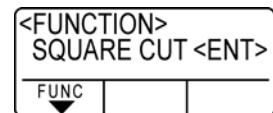

2

Press the jog key **[▲]** or **[▼]** to select [SET UP] .

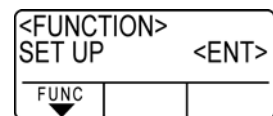

3

Press the **[ENTER/HOLD]** key.

4

Press the jog key **[▲]** or **[▼]** to select [ROTATION] .

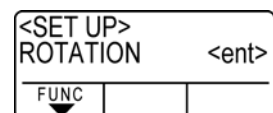

5

Press the **[ENTER/HOLD]** key.

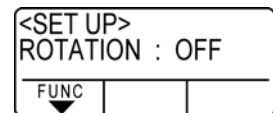

6

Press the jog key **[▲]** or **[▼]** to select Setting.

- ON : Performs the rotation of the axes of coordinates and the movement of the origin at the same time.
- OFF : Does not perform the rotation.

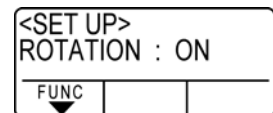

7

Press the **[ENTER/HOLD]** key.

8

Press the **[END]** key twice for terminating this function.

Coordinate system

The plotter has four different coordinate systems established by combinations of the sheet setting direction and the rotation of the coordinate axes.

< 0° ROTATION >

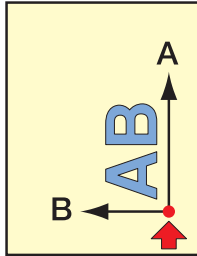

Rotation: OFF

The sheet is loaded in the rear of the plotter.

< 90° ROTATION >

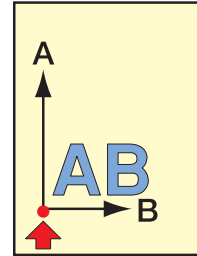

Rotation: ON

The sheet is loaded in the rear of the plotter.

< 180° ROTATION >

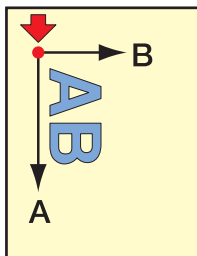

Rotation: OFF

The sheet is loaded in the rear of the plotter.

< 270° ROTATION >

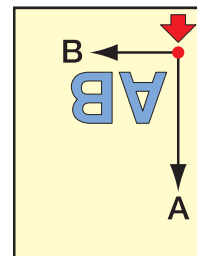

Rotation: ON

The sheet is loaded in the rear of the plotter.

Reset the Setting of ROTATION.

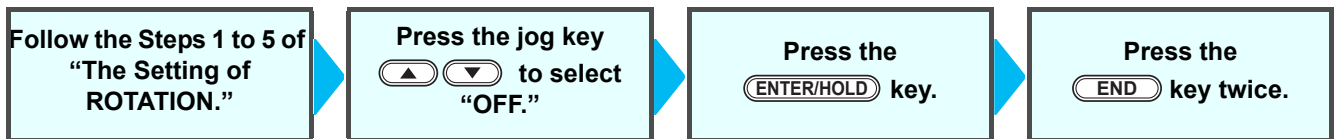

Perform DIVISION cut

When you set division cut for the width direction (Y), you can cut the data bigger than the sheet width by dividing it (DIVISION cut function).

In addition, when you set division cut for the feeding direction (X), you can cut the long data by dividing it and you can prevent cutting misalignment due to sheet meandering.

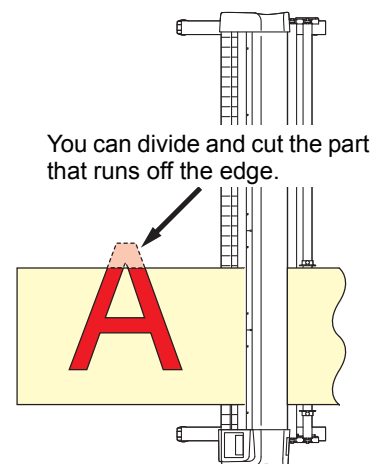

- With the DIVISION CUT function, you can use the following convenient functions too.
- **Perform a frame cut:**
Together with the cut data, the plotter automatically cuts out the frame fitted to the size of the cut data.
- **Put a mark for leaving a margin for gluing:**
You can put a "mark" for showing the point for gluing together the division cut sheets.

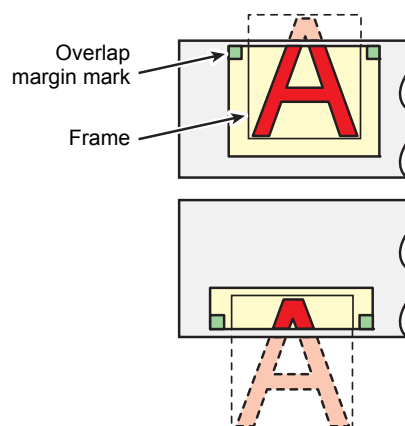

Set the Y direction (width direction) DIVISION cut

1

Press the **[FUNCTION]** key in the local mode.

```
<FUNCTION>
SQUARE CUT <ENT>
-----
FUNC  |   |   |
  ▼   |   |   |
```

2

Press the jog key **[▲]** or **[▼]** to select [SET UP] .

```
<FUNCTION>
SET UP      <ENT>
-----
FUNC  |   |   |
  ▼   |   |   |
```

3

Press the **[ENTER/HOLD]** key.

4

Press the jog key **[▲]** or **[▼]** to select [DIVISION CUT].

```
<SET UP>
DIVISIONcut <ent>
-----
FUNC  |   |   |
  ▼   |   |   |
```

5

Press the **[ENTER/HOLD]** key.

```
<SET UP>
DIV.CUT: OFF
-----
FUNC  |   |   |
  ▼   |   |   |
```

6

Press the jog key  or  to select “Y”



<SET UP>		
DIV.CUT: Y		
FUNC		
▼		

7

Press the  key.

<SET UP>		
FRAME CUT : OFF		
FUNC		
▼		

8

Press the jog key  or  to select [FRAME CUT].

- Select “ON” for the frame cut.

<SET UP>		
FRAME CUT : ON		
FUNC		
▼		

9

Press the  key.

<SET UP>		
MARK CUT : OFF		
FUNC		
▼		

10

Press the jog key  or  to select [MARK CUT].

- Select “ON” for the mark cut.

<SETUP>		
MARK CUT : ON		
FUNC		
▼		

11

Press the  key to perform setting, and press the  key twice to terminate this function.

Important!

- The setting values are kept in memory even when the power is turned off.
- Since the overlap margin is 1 cm, the available cutting area must be wider than 1 cm.
- During execution of division cutting, the plotter ignores any other data sent from the host computer.
- In any of the following cases, the plotter cannot perform division cutting.
 - The data size is larger than the receiver buffer capacity.
 - An origin renewal command is contained in the cutting data.
 - A two-point compensation value has been set.
 - The registration mark detection is being performed.
 - The width of available cutting area is 1 cm or less.
 - The plotter cuts the test data stored in it.
- When you use FineCut, the default value of Origin Renewal is “ON”. If you perform [DIVISIONcut], uncheck the checkbox. (Refer to FineCut OPERATION MANUAL Chapter5 “Setting Head Position after Plotting”)

Set the X direction (feeding direction) DIVISION cut

If the data size of the feeding direction exceeds the division length and cross cut length, the machine cuts it at that position by dividing it.

If the cross cut length is set, the machine cuts by overlapping it by the set value.

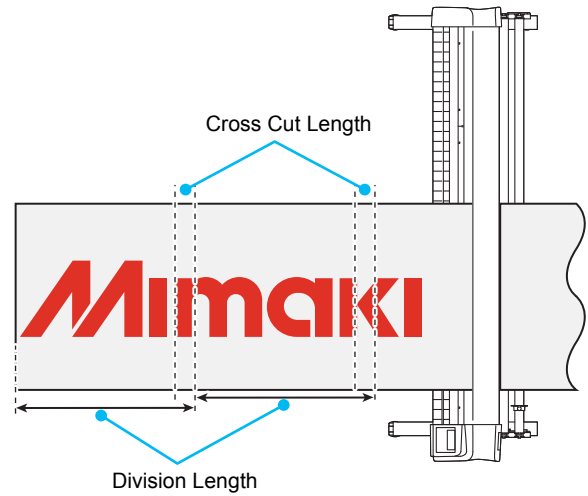

1 Press the **FUNCTION** key in the local mode.

<FUNCTION> SQUARE CUT <ENT>		
FUNC		

2 Press the jog key **▲** or **▼** to select [SET UP].

<FUNCTION> SET UP <ENT>		
FUNC		

3 Press the **ENTER/HOLD** key.

4 Press the jog key **▲** or **▼** to select [DIVISION cut].

<SET UP> DIVISIONcut <ent>		
FUNC		

5 Press the **ENTER/HOLD** key.

<SET UP> DIV.CUT: OFF		
FUNC		

6 Press the jog key **▲** or **▼** to select "X".

<SET UP> DIV.CUT: X		
FUNC		

7 Press the **ENTER/HOLD** key.

<SET UP> DIV.LENG: 50 cm		
FUNC		

8

Press the jog key  or  to select [DIV.LENG] .

• **Setting value**

In "mm" : 50cm to 500 cm (in increments of 50cm)

In "inch" : 1 to *** feet (in increments of 1 ft.)

- When it exceeds the set value, the machine cuts it at that position by dividing it.



<SET UP>		
DIV.LENG: 100 cm		
FUNC		

9

Press the  key.

<SET UP>		
CROSS CUT: 2mm		
FUNC		

10

Press the jog key  or  to select [CROSS CUT] .

• **Setting value**

In "mm" : 0mm to 50mm (in increments of 1cm)

In "inch" : 1 to *** feet (in increments of 1 ft.)

- The machine cuts by overlapping it by the set value.

<SET UP>		
CROSS CUT: 10mm		
FUNC		

11

Press the  key to perform setting, and press the  key twice to terminate this function.

Important!

- The setting values are kept in memory even when the power is turned off.
- During execution of division cutting, the plotter ignores any other data sent from the host computer.
- In any of the following cases, the plotter cannot perform division cutting.
 - The data size is larger than the receiver buffer capacity.
 - An origin change command is contained in the cutting data.
 - A two-point compensation value has been set.
 - The registration mark detection is being performed.
 - The plotter cuts the test data stored in it.

Reset the setting for DIVISION CUT.

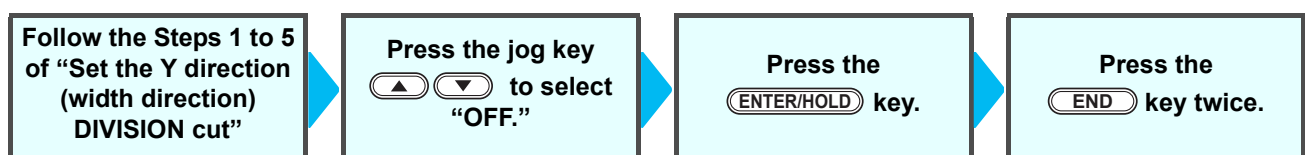

Cut Data via DIVISION CUT.

1 Send data from the host computer to the plotter.

- If the data exceeds the available cutting area, the display shown at right will appear.

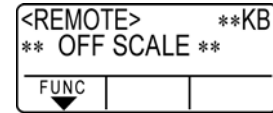
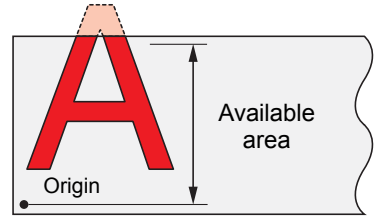

2 When cutting completes, the plotter automatically cuts the frame and area marked for gluing.

- On the display panel, the time for completing cutting of the frame and area marked for gluing appears.

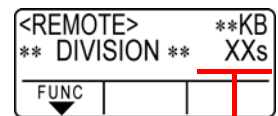

The remaining time until the completion of cutting the frame and marks

Important!

- For division cut in the X direction (feeding direction), when cutting (drawing) of the set area has been completed, the machine performs feeding and if it is not sheet end, copying/ cutting (drawing) automatically starts.
- If it is sheet end, division cut in the X direction (feeding direction) is terminated.

3 Upon completion of the frame cutting, the plotter will return to local mode.

- Do not replace the sheet when any other display is shown.

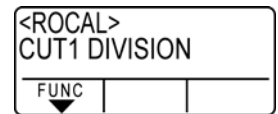

4 Set the new origin.

- Move the carriage using jog keys (arrow keys) to establish the origin.
- If the sheet has no space for cutting, replace the sheet with a new one.

5 Press the **REMOTE** key to set the plotter in remote mode.

- Feed the sheet by the maximum sheet length necessary for the cutting data and start cutting.
- If the sheet is not fed or the sheet is not sufficiently long, replace the sheet with a larger one in step 4 above.

6 Repeat steps 4 and 5.

- Repeat those steps until there is no data that exceeds the sheet width.
- Upon completion of cutting for all the data, the plotter will return to local mode, displaying the tool conditions

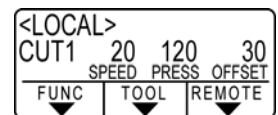

Change the cutting (plotting) order

You can reorder or sort the cut data that has been sent from the host computer to change the order for cutting (SORTING function).

Suppose that there is data that you want to cut just like drawing a picture with a single stroke, according to the order in which data is sent from application software. But in case you cannot do it in one continuous pen stroke, you can change the cutting order to make it.

(This function may not be supported depending on the firmware version.)

You cannot perform such one-stroke cutting in the following cases

Some applications software send data to the plotter in the order that the data has been created and edited.

- For example, in case you have modified the data read in via scanner, you cannot cut it in one stroke as the modified part is cut later.

When you want to cut after SORTING

With the sorting function, the plotter handles a piece of data corresponding to each cutting operation that starts with pen down and ends with pen up as one block. After the completion of cutting one block, the plotter will perform cutting of another block whose starting point is closest to the finished block.

For data transmitted from the host computer, the starting position and cutting direction will not be changed.

- : Starting point of data = Starting point of cutting
- Arrow : Direction of data = Cutting direction
- Number : Block cutting order

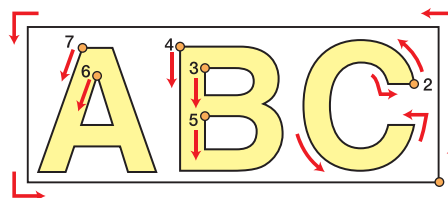

With the SORTING function, you can perform the following.

Set the SORTING function to "ON," and then the following functions become effective.

Auto feed function :

This is to detect the length of data to be cut, and to draw out a sheet with that data length in advance.

Area Control function :

This is to previously specify an area and to cut by priority a block data that can be contained in that area. When the data that can be included in that area runs out, the plotter expands the area to gradually perform cutting in the sheet feed direction.

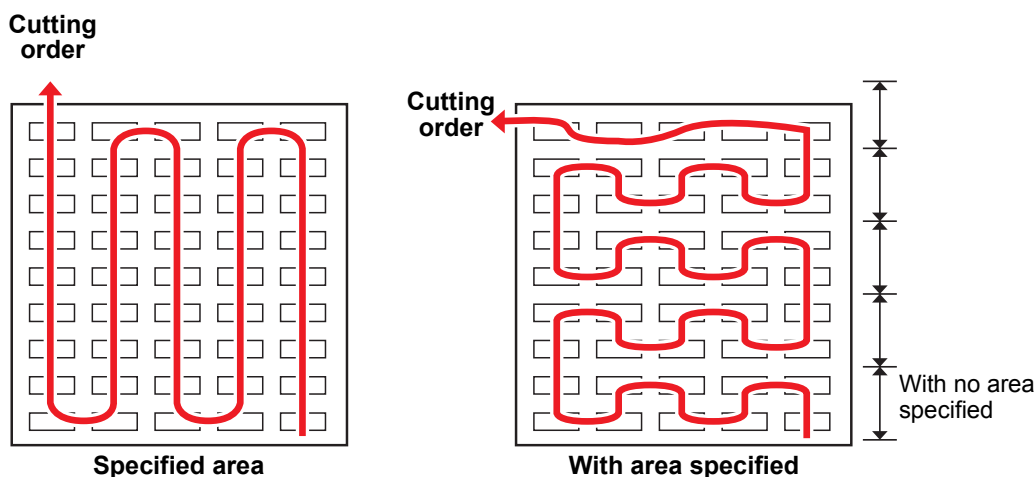

Set SORTING .

1

Press the **FUNCTION** key in the local mode.

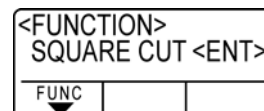

2 Press the jog key  or  to select [SET UP] .

<FUNCTION> SET UP		<ENT>
FUNC		

3 Press the  key.

4 Press the jog key  or  to select [SORTING] .

<SET UP> SORTING		<ent>
FUNC		

5 Press the  key.



<SET UP> SORTING:OFF		
FUNC		

6 Press the jog key  to select "ON" .

<SET UP> SORTING:ON		
FUNC		

7 Press the  key.

<SET UP> AUTO FEED:OFF		
FUNC		



8 Press the jog key  or  to select the setting of [AUTO FEED] .

- Select "ON" for performing AUTO FEED.

<SET UP> AUTO FEED:ON		
FUNC		

9 Press the  key.

<SET UP> AREA:OFF		
FUNC		

10 Press the jog key  or  to select the setting of [AREA].

- Setting values : OFF or 10 to 5,100cm (in 10cm increment)

<SET UP> AREA:10cm		
FUNC		

11 Press the  key for setting, and press the  key.

- Important!**
- The setting values are kept in memory even when the power is turned off.
 - Changing the setting value will clear the data in the receiver buffer.
 - Setting the sorting function to ON will decrease the size of the receiver buffer to about 20 MB.

Reset the Setting of SORTING.

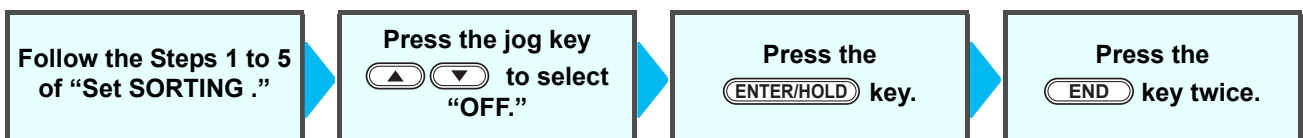

Sorting sequence

1

Data transmission is started.

- The size of unprocessed data in the receiver buffer is displayed.
- Cutting is not performed. The processed line segments are stored in the sorting buffer.

<REMOTE>			1356KB
CUT1	60	20	30
	SPEED	PRESS	OFFSET
			REMOTE

2

After completion of data transmission, the display shows the waiting time for the start of cutting.

- Remaining time is displayed in seconds.
- If no data is received during waiting for the start of cutting, the counter continues counting down.

** Plot **			10s
CUT1	60	20	30
	SPEED	PRESS	OFFSET
			REMOTE

3

Auto-feed is executed.

- Before starting cutting, the plotter feeds out the sheet by the length equivalent to the cutting data. If the sheet is not long enough to cover the cutting data, the error shown below is displayed.

** Sorting **			1%
CUT1	60	20	30
	SPEED	PRESS	OFFSET
			REMOTE

ERROR C15 AUTO FEED		
FUNC		

After replacing the sheet with a long sheet, perform data transmission or execute [No.COPIES].
(☞ P.3-9)

4

Cutting starts.

- The data percentage for which cutting has been already performed is displayed.

** Sorting **			100%
CUT1	60	20	30
	SPEED	PRESS	OFFSET
			REMOTE

5

Cutting is completed.

- The plotter returns to remote mode.

<REMOTE>			0KB
CUT1	60	20	30
	SPEED	PRESS	OFFSET
			REMOTE



- When SORTING is set to ON, the plotter will not start cutting until the specified close time elapses after receiving all pieces of cutting data.
In the following cases, however, the received pieces of data are sorted and cutting is started before the lapse of the close time.
 - The sorting buffer is full of data.(Approximately 500,000 line segments.)
 - The Tool number, SPEED, PRESSURE or any other cutting condition has been changed.
 - The feed command or origin change command is executed.

Other Useful Functions

Feed the paper

Before starting cutting (plotting), feed the sheet manually by the length to be used.

In addition, by feeding the sheet beforehand, you can check for a skew of the sheet or prevent skew while cutting (plotting) the long data.

Important!

- If you start the plotter for high-speed cutting without feeding the leading edge of the roll sheet by some length beforehand, there may be a case where the feeding the sheet is not started and thus the plotter goes into an error state.
- Feed function does not work until the sheet is detected.

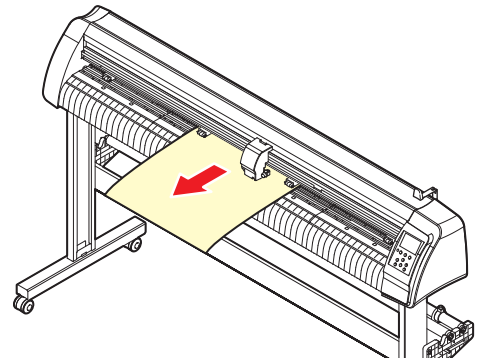

1 Press the **[FUNCTION]** key in the local mode.

```
<FUNCTION>
SQUARE CUT <ENT>
-----
FUNC
```

2 Press the jog key **[▲]** or **[▼]** to select **[FEED]** .

```
<FUNCTION>
FEED <ENT>
-----
FUNC TOOL REMOTE
```

3 Press the **[ENTER/HOLD]** key.

```
<FEED>
SHEET FEED :10.0m
-----
FUNC TOOL REMOTE
```

4 Input the feed amount using the jog key **[▲]** or **[▼]** .

• **Setting value**

- In "mm" : 0.1 m to 51.0 m (in increments of 0.1 m)
- In "inch" : 1 to 167 feet (in increments of 1 ft.)

```
<FEED>
SHEET FEED :10.0m
-----
FUNC TOOL REMOTE
```

5 Press the **[ENTER/HOLD]** key.

- Pull out an amount equal to the feed offset amount (P.3-57) added to the input length.

```
<FEED>
SHEET FEED :8.0m
-----
FUNC TOOL REMOTE
```



- To interrupt the sheet feeding, press the **[END]** key.
- If the sheet length is shorter than the set value, feeding is performed with the sheet that was pulled out.

```
<FEED>
** STOP :0.2m **
-----
FUNC TOOL REMOTE
```

HOLD

If a sheet goes out of alignment while long data is being cut (picture-drawn), you can temporarily hold the cut for fixing the misalignment of the sheet.

Important!

- When correcting the displacement of the sheet, move neither the carriage nor the pinch rollers. If they are moved out of position, a damage to the device or an error will arise.

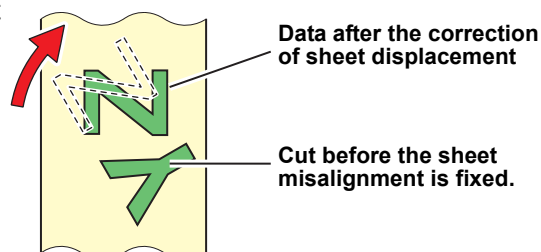

1

Press the **ENTER/HOLD** key during data cutting.

- Press the **ENTER/HOLD** key between figures. If you press it in the middle of the line, the cut line does not match each other.

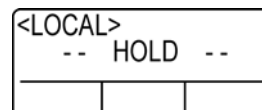

2

Fix the sheet misalignment.

- (1) Move down the clamp lever to the rear.
- (2) Fix the sheet misalignment.
- (3) Move down the clamp lever to the front.
- (4) Press the **END** key.

3

Press the **REMOTE** key to restart cutting.



- The **ENTER/HOLD** key does not work until the sheet is detected.
- In the local mode, hold down the **ENTER/HOLD** key for approximately 2.5 seconds.

DATA CLEAR - Discontinue Plotting -

Execute the DATA CLEAR function to discontinue cutting (plotting) for data.

If you do not perform DATA CLEAR, the plotter will perform cutting for the received data when it is returned to the remote mode.

Once DATA CLEAR is executed, the plotter will perform cutting (plotting) for new data, if received after the plotter is set to the remote mode.

1

Press the **REMOTE** key during data cutting.

2

Press the **FUNCTION** key.

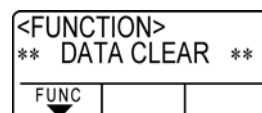

3

Press the **ENTER/HOLD** key.

Important!

- Do not perform DATA CLEAR while the host computer is sending data.



- Even after execution of DATA CLEAR, the received data remains in the receiver buffer. Cutting (plotting) can be repeated by the No. COPIES function.

Perform SAMPLE CUT to Find out the Cause of Cutting Error.

In case that normal data cutting cannot be performed etc., perform cutting with the sample stored in this plotter to find out the cause of cutting error.

Important!

- Execution of SAMPLE CUT will clear the data in the receiver buffer.

SAMPLE“Cut”

Cut

SAMPLE“Logo”

Mimaki

- 1** Press the **FUNCTION** key in the local mode.

<FUNCTION> SQUARE CUT <ENT>
FUNC

- 2** Press the jog key **▲** or **▼** to select [SAMPLE CUT].

<FUNCTION> SAMPLE CUT <ENT>
FUNC

- 3** Press the **ENTER/HOLD** key.

<SAMPLE CUT> Cut <ent>
FUNC

- 4** Press the jog key **▲** or **▼** to select the SAMPLE DATA to be cut.

- There are two types of samples, “Cut” and “Logo.” If you select “Cut,” proceed to Step 7.

<SAMPLE CUT> LOGO 100% <ent>
FUNC

- 5** Press the **ENTER/HOLD** key.

<SAMPLE CUT> LOGO 100% <ent>
FUNC

- 6** Select scale factor using the jog key **◀** or **▶** key to cut Logo.

- Scale factor: 1 to 999%

<SAMPLE CUT> LOGO 200% <ent>
FUNC

- 7** Press the **ENTER/HOLD** key for starting cutting.

Result of SAMPLE CUT

Sample data can be cut successfully, but other data cannot.

The host computer is faulty.

Sample data as well as other data cannot be successfully cut either. (When leaving the start/end lines without cutting off)

Increase the set value of [ADJ-PRS OFS] to raise the pressure for pressing the cutter blade down.

Output the Setting List

You can keep this plotted sheet for your future reference or transmit this document by facsimile when you contact your local distributor for maintenance.

- 1 Set a A4-size discard sheet in a longitudinal direction (☞ P.2-16) , and replace the tool with “pen” (☞ P.2-6) .

- 2 Press the **FUNCTION** key in the local mode.

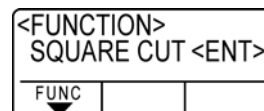

- 3 Press the jog key or to select [LIST] .

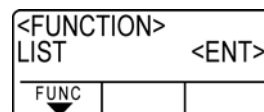

- 4 Press the **ENTER/HOLD** key.

- Output the setting list.

Important!

- When you press the **END** key, outputting of the list stops. You cannot start at the position where you stop. You have to start outputting from the top of the list.

Important!

- You cannot check the contents of this list directly on the computer.
- If A4 paper is set, set so that edges of the pinch roller and the paper are aligned.

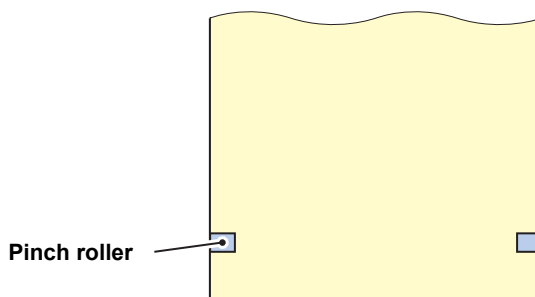

- LIST function cannot be executed if the rotation function is specified. In such cases, "ERROR 901 OPERATION" is displayed.
- Turn the rotation function off before executing LIST.

Output the received data by the ASCII code [ASCII DUMP]

This function makes the host computer send data to the plotter, and makes the plotter plot the data in ASCII format.

The dump can be executed through the interface to which the host computer is connected.

1 Replace the tool with “pen” (☞ P.2-6) .

2 Press the **FUNCTION** key in the local mode.

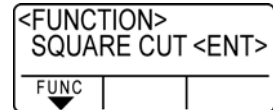

3 Press the jog key or to select [ASCII DUMP].

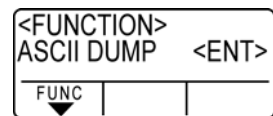

4 Press the **ENTER/HOLD** key.

Important!

- You cannot check the dumped contents directly on the computer.



- To cancel the dump function, press the **REMOTE** key to return to the local mode and execute DATA CLEAR (☞ P.3-48) ,
- If executing a dump, perform sheet detection by using rear set (press). (☞ P.2-15)

Set the configurations with a computer

Set the configurations with a computer

Set the communication condition with the RS-232C interface. Settings of the communication conditions differ with the command (AUTO, MGL-I c1 or MGL-II c) specified using the command change-over function.

Important!

- If you have changed the step size, be sure to raise the pinch rollers using the sheet set lever and re-load the sheet on the device.

1 Press the **FUNCTION** key in the local mode.

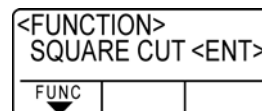

2 Press the jog key or to select [SET UP] .

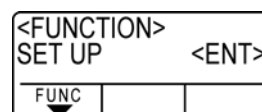

3 Press the **ENTER/HOLD** key.

4 Press the jog key or to select [INTERFACE] .

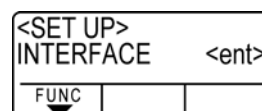

5 Press the **ENTER/HOLD** key.

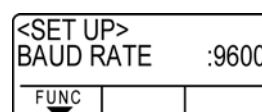

6 Press the jog key or to select [BAUD RATE].

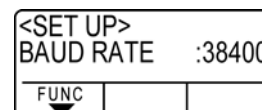

- Set values: 1200, 2400, 4800, 9600, 19200, 38400(bps)

Important!

- The recommended setting value is “38400(bps)”.
- Set the transfer speed of the host computer to CG-SR111.

7 Press the **ENTER/HOLD** key.

8 Press the jog key or to select the following items.

- The following items are provided for the setting of registration mark detection:
Data bits, Parity / Stop bits / Handshake / Step size / Close time
- See pages P.3-53 for the contents of each setting item.

9 Press the **ENTER/HOLD** key.

10 Press the jog key or to select the set values.

- See pages P.3-53 for the contents of each setting item.

11 Press the **ENTER/HOLD** key to confirm the value.

12 When you want to terminate this procedure, press the **END** key twice.

Setting Items

Boud rate	1200, 2400, 4800, 9600, 19200, 38400(bps)	
Data bits	7, 8(bit)	
Parity	NON, EVEN, ODD	
Stop bits	1, 2(bit)	
Handshake	MGL-IIc	HARD, ENQACK, X-PRM, SOFT
	MGL-Ic1	HARD, XONOFF
Step size	AUTO (MGL-IIc)	0.025 (mm)
	AUTO(MGL-Ic1)	0.05 (mm)
	MGL-IIc	0.025, 0.01 (mm)
	MGL-Ic1	0.05, 0.025, 0.1 (mm)
Close tim ^{*1}	3 to 60 (Seconds)	

*1. Sets the segmentation of the target data for multiple cut, waiting time before starting division cut or waiting time before starting sorting output. The setting range is 3 to 60 seconds. If no data is received when the established waiting time has elapsed after the completion of cutting, the device will judge that one piece of data has completed to enable discrimination between the completed data and the subse-quent data.

Make the media without uncut area

By over lapping the start point and the end point arbitrarily, you can make the media without uncut area.

Specify the over cut function (valid/invalid) and the length of the over cut. If the length of the over cut is set, when cut starts, cut will be performed from the position to the front by the specified length and the tool will move up going too far at the end.

Additionally, you can enable the corner cut function to perform over-cutting of corners other than the start and end points.

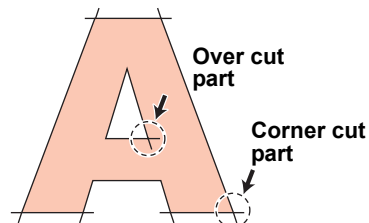

Important!

- Setting proper over cut can reduce uncut area of start and end point of a media easy to bend. If too large value is set, the result may have a rupture

1

Press the **FUNCTION** key in the local mode.

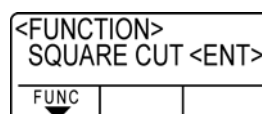

2

Press the jog key or to select [SET UP] .

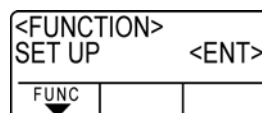

3

Press the **ENTER/HOLD** key.

4

Press the jog key or to select [OVER CUT].

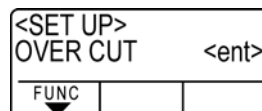

5

Press the **ENTER/HOLD** key.

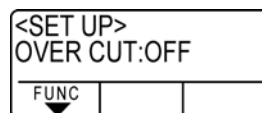

6

Press the jog key or to select OVER CUT setting.

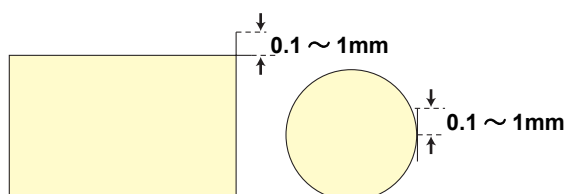

- Setting value: OFF or a value from 0.1 to 1.0mm (0.1mm unit)



7

Press the **ENTER/HOLD** key.

8

Press the jog key  or  to select **CORNER CUT** setting.

• Setting value: ON/OFF

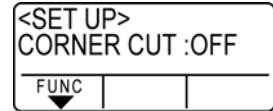
**9**

Press the  key.

10

Press the  key twice for terminating this function.

Select the number of pinch roller to use

Set the number of pinch roller to detect when the sheet detection.
For the machine with more than three pinch rollers, it is displayed.

1

Press the **FUNCTION** key in the local mode.

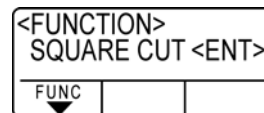

2

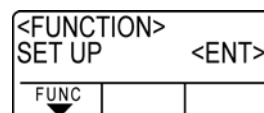

Press the jog key  or  to select [SET UP] .



3

Press the **ENTER/HOLD** key.

4

Press the jog key  or  to select [PINCH ROLL] .

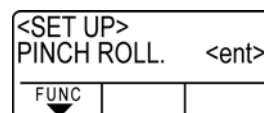

5

Press the **ENTER/HOLD** key.

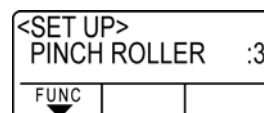

6

Press the jog key  or  to select the number of pinch roller to detect.

• PINCH ROLL: 2 or 3

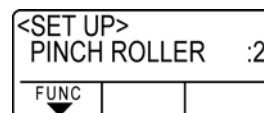

7

Press the **ENTER/HOLD** key.

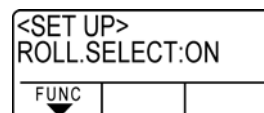

8

Press the jog key  or  to select the setting of "ROLL. SELECT".

• When selecting the number of pinch roller at sheet detection, select "ON".

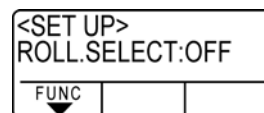

9

Press the **END** key twice for terminating this function.



• If "2" is set to "PINCH ROLL" and "OFF" is set to "ROLL. SELECT", only 2 pinch rollers will be detected at sheet detection.



• When using wider sheet, you may wish to limit the number of pinch roller because you do not want to leave the trace of the roller on the sheet. In such a case, as there is the possibility that the sheet driving accuracy will become lower, make the cutting speed and up speed low enough or set "HEAVY" to [SHEET TYPE] to limit the driving speed. By doing this, you can gain better cutting result.

Setting the FEED OFFSET

You can perform extra feeding when feeding sheets by pre-feed or similar method. By performing extra feeding, you can ensure slack required for cutting (plotting).

Important!

- When the remaining amount of the roll sheet is less, sheet rewind may occur due to shaking during operation, and lack of sheet slack may occur. It may cause incorrect cutting (plotting). However, using this function, you can reduce this problem.
- The set value is retained even when the power is turned "OFF".
- When over feeding is set, the setting of feed offset becomes "invalid".

1 Press the **FUNCTION** key in LOCAL mode.

<FUNCTION>	SQUARE CUT	<ENT>
FUNC		

2 Press the jog key  or  to select [SET UP].

<FUNCTION>	SET UP	<ENT>
FUNC		

3 Press the **ENTER/HOLD** key.

4 Press the jog key  or  to select [FEED OPTION].

<SET UP>	FEED OPTION	<ent>
FUNC		

5 Press the **ENTER/HOLD** key.

<SET UP>	FEED OFFSET	<ent>
FUNC		

6 Press the **ENTER/HOLD** key.

<SET UP>	FEEDoffset:	0cm
FUNC		

7 Press the jog key  or  to select the offset value.

- Setting value : 0 to 100cm

<SET UP>	FEEDoffset:	10cm
FUNC		

8 Press the **ENTER/HOLD** key.

9 Press the **END** key several times to end the setting.

Setting the FEED SPEED

In the case of using especially heavy roll sheet, the machine burden is reduced by slowing down the feed speed.

1 Press the **FUNCTION** key in LOCAL mode.

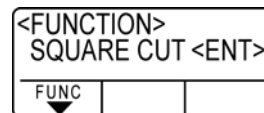

2 Press the jog key or to select [SET UP].

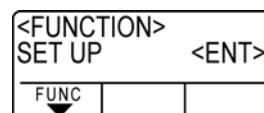

3 Press the **ENTER/HOLD** key.

4 Press the jog key or to select [FEED OPTION].

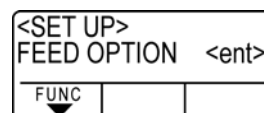

5 Press the **ENTER/HOLD** key.

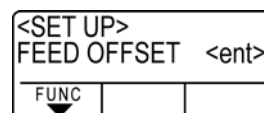

6 Press the jog key or to select [FEED SPEED].

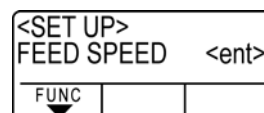

7 Press the **ENTER/HOLD** key.

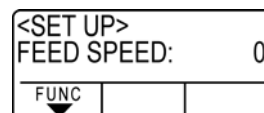

8 Press the jog key or to select the feed speed value.

• Setting value : 0 to 30cm/s

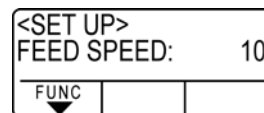

9 Press the **ENTER/HOLD** key.

10 Press the **END** key several times to end the setting.

Setting the PRE FEED

Perform next setting about automatic paper feeding after sheet detection.

Set Item	Set Value *1	Overview
Feed count	0, 1, 2, <u>3</u> , 4, 5	Sets the number of feedings of the sheet back and forth. By feeding the sheet, cutting (plotting) quality can be improved.  <ul style="list-style-type: none"> Use three times as a reference for the number of feedings. Change the number of feedings depending on the sheet to be used.
Feed length	0.1 to <u>0.3</u> to 5m	Sets the feed length of the sheet. By feeding the sheet by the amount to be cut (plotted) in advance, as the sheet can adjust itself to the work environment, cutting (plotting) quality can be improved.
Wait time	0 to <u>1</u> to 90 sec	Sets the time until cutting (plotting) starts after the sheet is fed.
Over feed	ON/ <u>OFF</u>	When you cut (plot) two and more pages, by feeding second sheet in advance, the cutting (plotting) efficiency can be improved when the waiting time is set.

*1. The setting at the time of purchase is indicated with the underline.

1 Press the **FUNCTION** key in LOCAL mode.

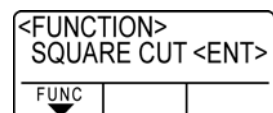

2 Press the jog key  or  to select [SET UP].

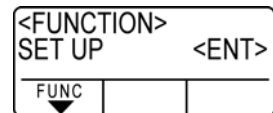

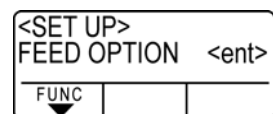

3 Press the **ENTER/HOLD** key.

4 Press the jog key  or  to select [FEED OPTION].

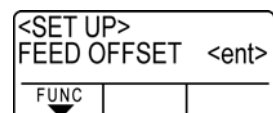

5 Press the **ENTER/HOLD** key.



6 Press the jog key  or  to select [PRE FEED].

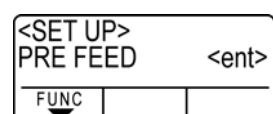

7 Press the **ENTER/HOLD** key.
 • The feed count setting is displayed.

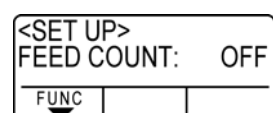

8

Press the jog key  or  to select a set value.

- Setting value : OFF, 1 to 5

<SET UP>		
FEED COUNT:		1
FUNC		
▼		

9

Press the  key.

- The next setting item is displayed.

<SET UP>		
FEED LENG:		3.0m
FUNC		
▼		

10

Repeat the procedures in the Step 8 and 9 to set other items.

- Perform the same operations as in Steps 8 and 9 to set other items.

11

Press the  key.

12

Press the  key several times to end the setting.

Important!

- The set value is retained even when the power is turned "OFF".

Set the network

You can also perform network setting with "Network Configurator", the tool to perform network setting of Mimaki's product. To download the Network Configurator, check "Driver / Utility" on the download page at Mimaki Engineering (<http://eng.mimaki.co.jp/download/>).

1 Press the **FUNCTION** key in the local mode.

<FUNCTION> SQUARE CUT <ENT>		
FUNC		

2 Press the jog key  or  to select [SET UP] .

<FUNCTION> SET UP <ENT>		
FUNC		

3 Press the **ENTER/HOLD** key.

4 Press the jog key  or  to select [NETWORK].

<SET UP> NETWORK <ent>		
FUNC		

5 Press the **ENTER/HOLD** key.

<Network> Info. IP Address <ent>		
FUNC		

6 Press the **ENTER/HOLD** key.

- The IP address currently used by this machine is displayed.

IP Addr. Info. 10. 16. 168.235		
FUNC		



- After connecting with the network, it takes time until the IP address is determined. If the IP address has not been determined, "0.0.0.0" is displayed.

7 Press the **ENTER/HOLD** key.

<Network> Info. IP Address <ent>		
FUNC		

8 Press the jog key  or  to select [MAC Address] .

<Network> Info. MAC Address <ent>		
FUNC		

9 Press the **ENTER/HOLD** key.



- The MAC address currently used by this machine is displayed.
- When you press , the remaining address is displayed.

MAC Addr. Info. 00 : d0 : 1b >		
FUNC		

10 Press the **ENTER/HOLD** key.

<Network> Info. MAC Address <ent>		
FUNC		



11

Press the jog key  or  to select [DHCP] .

<Network>		
DHCP		<ent>
FUNC		

12

Press the  key.

- Press   to set ON/ OFF.
- When it is ON, the IP address given by the DHCP server is used.



DHCP		
:ON		
FUNC		

13

Press the  key.

<Network>		
DHCP		<ent>
FUNC		



14

Press the jog key  or  to select [AutoIP] .

<Network>		
AutoIP		<ent>
FUNC		

15

Press the  key.

- Press   to set ON/ OFF.
- When it is ON, the IP address is determined by the AutoIP protocol. However, DHCP is ON, DHCP has priority.

AutoIP		
:ON		
FUNC		

16

Press the  key.

<Network>		
AutoIP		<ent>
FUNC		

17

Press the jog key  or  to select the set values.

- Both of DHCP and AutoIP is OFF, you can set IP Address/ Default Gateway/ DNS Address/ Sub Net Mask. For other than above, proceed to the Step 21.

18

Press the  key.

19

Press the jog key     to select the set values.

20

Press the  key to confirm the value.

21

Press the  key several times for terminating this function.



- To reflect network settings, turn OFF the power once and turn ON again.

Setting event mail function

Set the function to send e-mails to the set e-mail address when events such as cutting start/ end and stop due to an error.

You can also perform network setting with "Network Configurator", the tool to perform network setting of Mimaki's product. To download the Network Configurator, check "Driver / Utility" on the download page at Mimaki Engineering (<http://eng.mimaki.co.jp/download/>).

Disclaimer

- The customer is responsible for the communication fee for Internet communication such as e-mail notification.
- The notification by the event mail function may not be delivered due to Internet environment, failure of the device/ the power supply, etc. Mimaki has absolutely no responsibility for any damages or loss resulting from non-delivery or delays.

Important!

- You can use event mail function by connecting LAN to this machine. Please prepare for LAN cable connection beforehand.
- Not compatible with SSL communication.

Enable the event mail function

1

Press the **FUNCTION** key in the local mode.

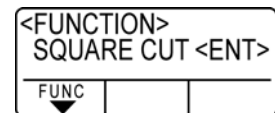

2

Press the jog key **▲** or **▼** to select [SET UP] .

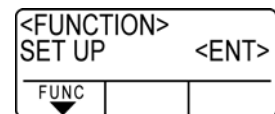

3

Press the **ENTER/HOLD** key.

4

Press the jog key **▲** or **▼** to select [EVENT MAIL] .

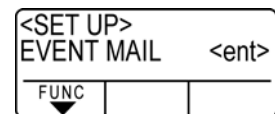

5

Press the **ENTER/HOLD** key.



6

Press the **ENTER/HOLD** key.

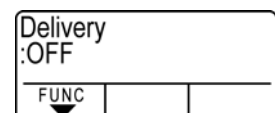

7

Press the jog key **▲** or **▼** to select "ON"

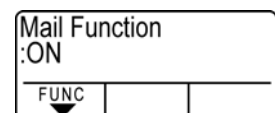

8

Press the **ENTER/HOLD** key.

<EVENT MAIL>		
Delivery		<ent>
FUNC		

9

Press the **END** key several times for terminating this function.

Set the event to send an event mail

- 1** Press the **FUNCTION** key in the local mode.

<FUNCTION> SQUARE CUT <ENT>
FUNC

- 2** Press the jog key **▲** or **▼** to select [SET UP] .

<FUNCTION> SET UP <ENT>
FUNC

- 3** Press the **ENTER/HOLD** key.

- 4** Press the jog key **▲** or **▼** to select [EVENT MAIL] .

<SET UP> EVENT MAIL <ent>
FUNC

- 5** Press the **ENTER/HOLD** key.

<EVENT MAIL> Delivery <ent>
FUNC

- 6** Press the jog key **▲** or **▼** to select [Event] .

<EVENT MAIL> Event <ent>
FUNC

- 7** Press the **ENTER/HOLD** key.

 - Set whether you send/ do not send the e-mail at the start of plotting.
 - Press **▲** **▼** to set ON/ OFF.

PlotStart Event :OFF
FUNC

- 8** Press the **ENTER/HOLD** key.

 - Set whether you send/ do not send the e-mail at the end of plotting.
 - Press **▲** **▼** to set ON/ OFF.

Plot End Event :OFF
FUNC

- 9** Press the **ENTER/HOLD** key.

 - Set whether you send/ do not send the e-mail when an error occurs.
 - Press **▲** **▼** to set ON/ OFF.

Error Event :OFF
FUNC

- 10** Press the **ENTER/HOLD** key.

 - Set whether you send/ do not send the e-mail when a warning occurs.
 - Press **▲** **▼** to set ON/ OFF.

Warning Event :OFF
FUNC

- 11** Press the **ENTER/HOLD** key.

<EVENT MAIL> Event <ent>
FUNC

12 Press the **END** key several times for terminating this function.

Set the e-mail address

1 Press the **FUNCTION** key in the local mode.

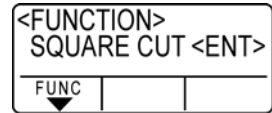

2 Press the jog key **▲** or **▼** to select [SET UP] .

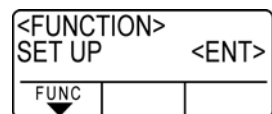

3 Press the **ENTER/HOLD** key.

4 Press the jog key **▲** or **▼** to select [EVENT MAIL] .

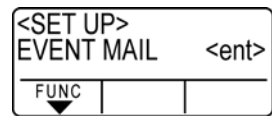

5 Press the **ENTER/HOLD** key.

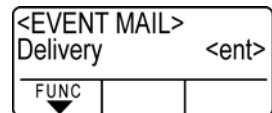

6 Press the jog key **▲** or **▼** to select [Address] .

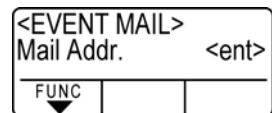

7 Press the **ENTER/HOLD** key.

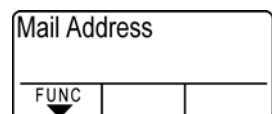

8 Press the jog key **▲** **▼** **◀** **▶** to set mail address.

- Set the e-mail address to which you send the event mail.
- Set it with alphanumeric characters and symbols within 96 characters.

9 Press the **ENTER/HOLD** key.

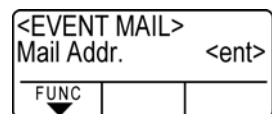

10 Press the **END** key several times for terminating this function.

Set the subject

1 Press the **FUNCTION** key in the local mode.

<FUNCTION> SQUARE CUT <ENT>		
FUNC		
▼		

2 Press the jog key **▲** or **▼** to select [SET UP] .

<FUNCTION> SET UP <ENT>		
FUNC		
▼		

3 Press the **ENTER/HOLD** key.

4 Press the jog key **▲** or **▼** to select [EVENT MAIL].

<SET UP> EVENT MAIL <ent>		
FUNC		
▼		

5 Press the **ENTER/HOLD** key.

<EVENT MAIL> Delivery <ent>		
FUNC		
▼		

6 Press the jog key **▲** or **▼** to select [Subject] .

<EVENT MAIL> Subject <ent>		
FUNC		
▼		

7 Press the **ENTER/HOLD** key.

Message Subject CG-SR3_1		
FUNC		
▼		

8 Press the jog key **▲** **▼** **◀** **▶** to set subject

- Set the characters to write in the subject of the event mail.
- Set it with alphanumeric characters and symbols within 8 characters.

9 Press the **ENTER/HOLD** key.

<EVENT MAIL> Subject <ent>		
FUNC		
▼		

10 Press the **END** key several times for terminating this function.

Set the server

- 1** Press the **FUNCTION** key in the local mode.

<FUNCTION> SQUARE CUT <ENT>
FUNC
▼
- 2** Press the jog key **▲** or **▼** to select [SET UP] .

<FUNCTION> SET UP <ENT>
FUNC
▼
- 3** Press the **ENTER/HOLD** key.
- 4** Press the jog key **▲** or **▼** to select [EVENT MAIL] .

<SET UP> EVENT MAIL <ent>
FUNC
▼
- 5** Press the **ENTER/HOLD** key.

<EVENT MAIL> Delivery <ent>
FUNC
▼
- 6** Press the jog key **▲** or **▼** to select [SERVER] .

<EVENT MAIL> Server <ent>
FUNC
▼
- 7** Press the **ENTER/HOLD** key.

SERVER SETUP SMTP Addr. <ent>
FUNC
▼
- 8** Press the **ENTER/HOLD** key.

 - Press the jog key **▲** **▼** **◀** **▶** to set SMTP server.
 - Input the SMTP server name or IP address.

SMTP Address
FUNC
▼
- 9** Press the **ENTER/HOLD** key.

SERVER SETUP SMTP Addr. <ent>
FUNC
▼
- 10** Press the jog key **▲** or **▼** to select [SMTP PORT] .

SERVER SETUP SMTP Port <ent>
FUNC
▼
- 11** Press the **ENTER/HOLD** key.

SMTP Port No. : 25
FUNC
▼
- 12** Press the jog key **▲** or **▼** to set [Auth.] .

13 Press the **ENTER/HOLD** key.

SERVER SETUP	
SMTP Port	<ent>
FUNC	

14 Press the jog key **▲** or **▼** to select [Auth.] .

SERVER SETUP	
Auth.	<ent>
FUNC	

15 Press the **ENTER/HOLD** key.

SERVER SETUP	
:POP before SMTP	
FUNC	

16 Press the jog key **▲** or **▼** to set [Auth.] .

- Set the authentication method of the SMTP server.
- When you select [OFF], proceed to the Step 32.

SERVER SETUP	
:POP before SMTP	
FUNC	

17 Press the **ENTER/HOLD** key.

SERVER SETUP	
Auth.	<ent>
FUNC	

18 Press the jog key **▲** or **▼** to select [Sender Adr].

SERVER SETUP	
Sender Adr.	<ent>
FUNC	

19 Press the **ENTER/HOLD** key.

- Press **▲** **▼** **◀** **▶** and set the e-mail address to be used as the sender mail address.
- Set it with alphanumeric characters and symbols within 64 characters.

Sender Mail Adr.	
FUNC	



- Depending on your server, if you do not set the e-mail address not supporting the account, sending/receiving e-mails may be unavailable.

20 Press the **ENTER/HOLD** key.

SERVER SETUP	
Sender Adr.	<ent>
FUNC	

21 Press the jog key **▲** or **▼** to select [User Name].

SERVER SETUP	
User Name	<ent>
FUNC	



22 Press the **ENTER/HOLD** key.

- Press **▲** **▼** **◀** **▶** to set the user name to use for the authentication.
- Set it with alphanumeric characters and symbols within 30 characters.

User Name	
FUNC	





23 Press the **ENTER/HOLD** key.

SERVER SETUP	
User Name	<ent>
FUNC	

24 Press the jog key  or  to select [Pass Word] .

SERVER SETUP	Pass Word	<ent>
FUNC		

25 Press the  key.

- Press     to set the password to use for the authentication.
- Set it with alphanumeric characters and symbols within 15 characters.





- On the password setting screen, the value currently set is not displayed. Only you can do is to enter the value newly.

Pass Word	*****	
FUNC		

26 Press the  key.

- When you select [POP before SMTP] in the Step 16, set the items in the Step 27 to 31.

SERVER SETUP	Pass Word	<ent>
FUNC		

27 Press the jog key  or  to select [POP3 Addr.] .

SERVER SETUP	POP3 Addr.	<ent>
FUNC		

28 Press the  key.

- Press the jog key     to set POP server.
- Set the server name or the IP address.

POP3 Address		
FUNC		



29 Press the  key.

SERVER SETUP	POP3 Addr.	<ent>
FUNC		

30 Press the jog key  or  to select [APOP] .

SERVER SETUP	APOP	<ent>
FUNC		

31 Press the  key.

- Press   to set ON/ OFF of APOP.

APOP	:ON	
FUNC		

32 Press the  key.

33 Press the  key several times for terminating this function.

Send a test e-mail

- 1** Press the **FUNCTION** key in the local mode.

<FUNCTION> SQUARE CUT <ENT>
FUNC

- 2** Press the jog key **▲** or **▼** to select [SET UP] .

<FUNCTION> SET UP <ENT>
FUNC

- 3** Press the **ENTER/HOLD** key.

- 4** Press the jog key **▲** or **▼** to select [EVENT MAIL] .

<SET UP> EVENT MAIL <ent>
FUNC

- 5** Press the **ENTER/HOLD** key.

<EVENT MAIL> Delivery <ent>
FUNC

- 6** Press the jog key **▲** or **▼** to select [Test] .

<EVENT MAIL> Test <ent>
FUNC

- 7** Press the **ENTER/HOLD** key.

Transmit Test EXECUTE :ent
FUNC

- 8** Press the **ENTER/HOLD** key.

 - The sent result is displayed.
 - If sending test e-mail has failed, an error code is displayed. Refer to the next page to solve the problem.

Transmit Test Success
FUNC

Transmit Test Failed 12345
FUNC

Error code

- 9** Press the **END** key several times for terminating this function.

Important!

- The sent result of the test e-mail is the result of e-mail sending process performed by this machine to the e-mail server. It does not indicate that the e-mail was received at the address.
- If the spam e-mail filter etc. has been set in the terminal in which e-mails are received, even if "Sending has been completed" is displayed, the e-mail cannot be received in some cases.
- If sending test e-mail has failed, the error below is displayed.
- If the error cannot be solved, try again after a while.
- For the server setting etc., contact with the network administrator or the provider.

Error Code	Error contents	Remedy
10	Network connection error	<ul style="list-style-type: none"> • Check that the machine is connected with the network. • Check that the machine IP address is correct. • Check that the machine is in the environment where DNS is available.
20	No valid e-mail address.	<ul style="list-style-type: none"> • Enter the correct e-mail address.
11003 11004	The POP server cannot be found. Or cannot access DNS server.	<ul style="list-style-type: none"> • Check the POP server address. • Check that the machine is in the environment where DNS is available.
11021	Cannot connect with the POP server.	<ul style="list-style-type: none"> • Check the POP server setting. • Check the firewall setting.
12010	An error returns from the POP server.	<ul style="list-style-type: none"> • Check the POP server setting.
13000	The POP authentication has failed.	<ul style="list-style-type: none"> • Check the user name and the password. • Check the APOP setting.
10013 10014	The SMTP server cannot be found. Or cannot access DNS server.	<ul style="list-style-type: none"> • Check the SMTP server address. • Check that the machine is in the environment where DNS is available.
10021	Cannot connect with the SMTP server.	<ul style="list-style-type: none"> • Check the SMTP server setting. • Check the SMTP port number. • Check the firewall setting.
10*** 11*** 20*** 21***	An error returns from the SMTP server. Or, there was no response.	<ul style="list-style-type: none"> • Check the SMTP server setting. • Cannot communicate with a server that requires mandatory SSL communication. • Check protocol filter settings.
12***	It is invalid sender address.	<ul style="list-style-type: none"> • Check that the e-mail address supporting the account entered in the user name/ the password is set in "Sender mail Adr."
13***	The e-mail address cannot be found. Or, it is invalid sender address.	<ul style="list-style-type: none"> • Check the e-mail address. • Even if there is a mistake in the e-mail address, this error cannot be detected in some cases. • Check that the e-mail address supporting the account entered in the user name/ the password is set in "Sender mail Adr."
22008	SMTP authentication error	<ul style="list-style-type: none"> • The authentication method is not supported.
23*** 24*** 25***	The SMTP authentication has failed.	<ul style="list-style-type: none"> • Check the user name and the password.

*** is the error code returned from the e-mail server.

Confirming Machine Information

The information of this machine can be confirmed.
The following items can be confirmed as machine information.

Item	Description
MODEL	This displays the model name of the machine.
F/W ver.	This displays the firmware version of the machine.
SERIAL No.	This displays the serial number of the machine.
IP Address	This displays the IP address of the machine.

Displaying the Information / IP address

1 Press the **FUNCTION** key in LOCAL.

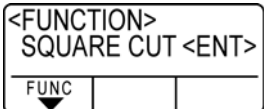

2 Press **▲** **▼** to select [INFORMATION].



3 Press the **ENTER/HOLD** key.



4 Press **▲** **▼** to select the machine information to display.

5 Press the **ENTER/HOLD** key.

- The Information is displayed.

MODEL

Displays model name.

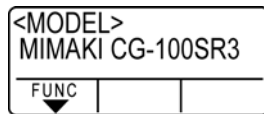

F/W version

Displays firmware version.

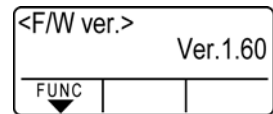

Serial No.

Displays serial number.

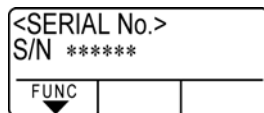

IP address

Displays IP address in use.

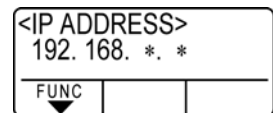

Miscellaneous Settings

Switch the display language

You can select the display language.

(it is set to “English” when you purchase this plotter).

Languages you can select : Japanese, English, German, French, Spanish, Italian, Portuguese
Chinese, Korean, Thai, Russian

1 Press the **FUNCTION** key in the local mode.

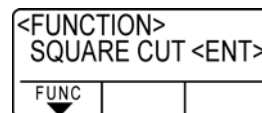

2 Press the jog key  or  to select [DISPLAY].

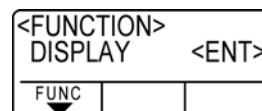

3 Press the **ENTER/HOLD** key.



4 Press the jog key  or  to select a language.

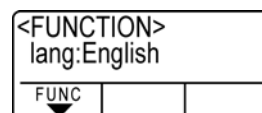

5 Press the **ENTER/HOLD** key.

6 Press the **END** key twice for terminating this function.

Switch the User

For CG-SRIII, you can save the setting value (cutting condition, distance correction and main body setting) by eight users from the User 1 to 8.

By changing the user number depending on the user, you can change the environment without resetting these parameters.

Important!

- You cannot change the user while the cutting operation stops. First, clear data and then change the user.
- When you change the user, sheet detection becomes invalid. Perform sheet detection again.

1

Press the **FUNCTION** key in the local mode.

<FUNCTION> SQUARE CUT <ENT>		
FUNC		
▼		

2

Press the jog key **▲** or **▼** to select [USER CHANGE].

<FUNCTION> USER CHANGE<ENT>		
FUNC		
▼		

3

Press the **ENTER/HOLD** key.

<FUNCTION> USER No. :1		
FUNC		
▼		

4

Press the jog key **▲** or **▼** to select a user.

<FUNCTION> USER No. : 8		
FUNC		
▼		

5

Press the **ENTER/HOLD** key.

6

Press the **END** key twice for terminating this function.

Other Convenient Settings

Change the settings according to your use.

1 Press the **FUNCTION** key in the local mode.

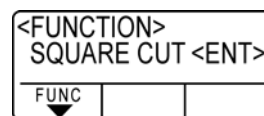

2 Press the jog key  or  to select [SET UP] .

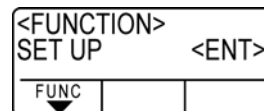

3 Press the **ENTER/HOLD** key.

4 Press the jog key  or  to select an item for setting.

• Refer to the setting list for selection.

5 Press the **ENTER/HOLD** key.

6 Press the jog key  or  to select the setting value.

• Refer to the setting list for selection. (☞ P.3-77)

7 Press the **ENTER/HOLD** key.

8 Press the **END** key twice for terminating this function.

Important!

• The setting values are kept in memory even when the power is turned off.

Setting List

Function name	Outline		Setting values	
Mark Detect	When you cut the data with registration marks, you must set without fail.		See P.3-16.	
Command Switching	Switch the unit of moving amount specified by a command.		AUTO	This is to automatically switch the command according to the command specifications of the receiving data.
			MGL-IIc	This is selected when the plotter receives the data of MGL-IIc command.
			MGL-Ic1	This is selected when the plotter receives the data of MGL-Ic1 command.
Interface	Set the configuration with a computer.		See P.3-52.	
Cutting Mode	This is to set the cutting quality.		Standard	This is a regular cutting mode.
			High speed	This is used to perform cutting in a short time (it is not appropriate for the heavy sheet).
			High quality	This is a cutting mode used to give priority to cutting quality.
Origin Switching	At the time of MGL-IIc command, this function sets the position of command origin. (At the time of MGL-Ic1 command, the command origin is positioned in the lower right.)		Center	This is to set the command origin in the center of effective cutting area.
			Lower right	This is to set the command origin in the lower right of effective cutting area.
Expands	Reduce the dead space to extend the cutting (plotting) area.		See P.3-35.	
Rotation	Switch the cutting direction.		See P.3-37.	
Buzzer	With this you can control the key-pressing sound and the alert sound caused at the time of error occurrence.	IP, VS, AS, FS, ZF, ZA, ZO	ON	This is for making the buzzer sound.
			OFF	This is not to make the buzzer sound (also make no confirmation response sound of registration mark sensor).
Division Cut	Set the division cut.		See P.3-39.	
Priority	When this plotter and the host computer make different settings on a same item, this function is used to set about which of the two must be given priority to (This is only for MGL-IIc).		Host	This is to give priority to the setting of host computer.
			Panel	This is to give priority to the setting of this plotter.
Size Response Value	This is used to set the largest response value of effective area read command from the host computer (This is only for MGL-Ic1).		1 to 51m	
Sheet Sensor	This is to detect the sheet existence and the sheet length.		ON	This is to detect them.
			OFF	This is not to detect them.
Up Speed	This is to set the speed of sheet and carriage movement when the tool is up. Setting the speed lower makes the sheet misalignment reduced at the time of long sheet feeding.		5,10,20,30,40,50,60,70,*180,90,100,AUTO (cm/s)	When setting to AUTO, the speed value set in the TOOL conditions is used as the up-speed.

*1. Up to 70 for the X axis.

Function name	Outline		Setting values		
Jog Step	This is to set the moving amount of carriage and sheet via the jog key.		0.1mm (set in mm)	0.1mm movement per jog key operation	
			1.0mm (set in mm)	1.0mm movement per jog key operation	
			1/16inch (set in inch)	1/16inch movement per jog key operation	
			1/254inch (set in inch)	1/254inch movement per jog key operation	
mm/inch	This is to select the unit with which you want to display the length.		mm	This is to display in mm.	
			inch	This is to display in inch.	
Feed Option	Feed Offset	Regarding AUTO FEED, this is to add the offset value to feed a little bit longer.	0 to 100cm	See P.3-57.	
	Feed Speed	Set the speed of feeding.	1 to 30cm/s	See P.3-58.	
	Pre Feed	Feed Count		OFF, 1 to 5	Performs the setting for automatic feeding after sheet detection and automatic cutting. (P.3-59)
		Feed Length		0.1 to 5m	
		Feed Wait		0 to 90 sec	
Over Feed		ON/OFF			
Dummy cutting	When this is set to "ON," the blade edge is made to turn to a specific direction before starting cutting, which allows dummy cutting.		ON	This is to perform dummy cutting every time the tool and cutting conditions are changed.	
			OFF	This is not to perform dummy cutting.	
Sheet setting	This is to set the types of sheet according to the sheet you use.		Standard	This is to be set when you use the regular sheet.	
			Heavy	This is to be set when you use heavier sheet than the regular one. (The maximum cut speed setting is limited to 20 cm/s and it moves at 20 cm/s even if the up-speed setting is set at 20 cm/s or more.)	
Sorting	This setting changes the cutting order and performs cutting.		See P.3-44.		
Compensated pressure offset	This is used to expand the value in such a case as when the beginning and end part of the cut are left cut.		±9	Around -30g to around 30g	
Pinch Roll	Select the number of pinch roller to use.		See P.3-61.		
Over Cut	Make the media without uncut area.		See P.3-54.		
Start Mode	Set the mode after detecting the sheet.		LCL	The mode switches to the standby condition of the local mode after detecting the sheet.	
			REM	The mode automatically switches to the remote mode after detecting the sheet.	
PRESS COMP.	Corrects variations in cutting pressure due to position in order to provide uniform cutting ability.		ON	Enables the function.	
			OFF	Disables the function	
Search Mark	Set the automatic registration mark search function performed after the sheet is detected.		See P.3-27.		
Pen Setting	Down Speed	Set the pen down speed.	0 to 20 to 64	The bigger the numerical value is, the faster the down speed becomes. *1	
Curve Mode*2	Set the drawing speed of curved lines.		FAST	The standard mode.	
			SLOW	Reduces the drawing speed of curved lines.	

*1. For the thick sheet of 1mm and more, if the down speed is too fast, the machine may drag the pen tip. In such a case, set the down speed to "20" and less.

*2. Use the "SLOW" setting to correct curved lines if they become twisted.

Function name	Outline		Setting values		
Up Hight	Set the height when lifting the tool		5 0 % , 7 5 % , 100%	Specify the height from the down position to the lifted position, with the approximate percentage of the stroke. The smaller the amount of the lifting, the faster the plotter cuts the media. For thick media or when the cutter scratches the media because the sheet is not flat, set the amount of lifting bigger.	
NET- WORK (☞ P.3-61)	Set the network.				
	IP Address	The IP address currently used by this machine is displayed.			
	MAC Address	The IP address currently used by this machine is displayed.			
	DHCP	ON	When it is ON, the IP address given by the DHCP server is used.		
		OFF			
	AutoIP	ON	When it is ON, the IP address is determined by the AutoIP protocol. However, DHCP is ON, DHCP has priority.		
		OFF			
	IP Address *1	Set the IP address used by this machine.			
	Def.Gateway *1	Set the default gateway used by this machine.			
DNS Address *1	Set the DNS server address used by this machine.				
SubNet Mask *1	Set the digit number of the subnet mask used by this machine.				
EVENT MAIL (☞ P.3-63)	Delivery	Set the event mail function.	ON	When the set event occurs, the function to send the e-mail becomes ON.	
			OFF	When the set event occurs, the function to send the e-mail becomes OFF.	
	Event	PlotStart Event		ON	Set whether you send/ do not send the e-mail at the start of plotting.
				OFF	
		Plot End Event		ON	Set whether you send/ do not send the e-mail at the end of plotting.
				OFF	
		Error Event		ON	Set whether you send/ do not send the e-mail when an error occurs.
				OFF	
	Warning Event		ON	Set whether you send/ do not send the e-mail when a warning occurs.	
			OFF		
	Address	Set the e-mail address to which you send the event mail.	Alphanumeric characters and symbols (within 96 characters)		
	Subject	Set the characters to write in the subject of the event mail.	Alphanumeric characters and symbols (within 8 characters)		
	SERVER	SMTP Address		Set the SMTP server.	
		SMTP PORT No.		Set the SMTP port number.	
		Sender Mail Adr.		Set the e-mail address to be used as the sender mail address.	
		Auth.	POP before SMTP	Set the SMTP server authentication method.	
			SMTP Auth		
OFF					
USER NAME *2		Set the user name used for the authentication.			
PASS WORD *2		Set the password used for the authentication.			
POP3 ADDRESS *3		Set the POP server.			
APOP *3		Set ON/ OFF of APOP.			
Test	Send the test e-mail.				

*1. Settable when both of DHCP and AutoIP are [OFF]

*2. Settable only when Auth. is not OFF

*3. Settable only when Auth. is POP before SMTP

Function name	Outline	Setting values
Setup Reset	Copy the set value to other user setting.	See P.3-84.
Setup Reset	Reset the setting values to the initial state.	See P.3-85.

Command Switching

- Changing the setting value will clear the data in the receiver buffer.
- With a large size of data, the [AUTO] mode may not function normally. In that case, change the setting to MGL - Ic1 or MGL-Ilc.
- Once the plotter receives data from the computer with [AUTO] selected, the display panel indicates the recognized command and the plotter starts cutting. The display panel may continue indicating a command name or display [ERR16 UTO I/F] if the command cannot be recognized automatically. In such a case, change the command setting to MGL-I c1 or the MGL- Ilc to perform normal cutting.
- The recognized command by [AUTO] will be effective until the data clear (☞ P.3-48) is executed or sheet setting is performed again.

Cutting Mode

Select "QUALITY" in any of the following cases:

- Characters whose sizes are 10 mm or less are to be cut
- Picture patterns or characters that have many sharp corners are to be cut
- Minute cutting is to be performed

However, the edges of finished patterns may be rugged if the data sent from the host computer is too complicated. In such a case, select "HIGHspd" for smooth finish.

Origin Switching

When the ROTATION function is ON, the origin is as follows:

Rotation : OFF

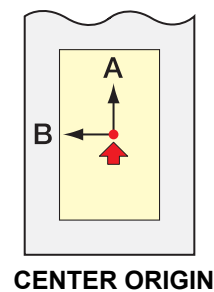
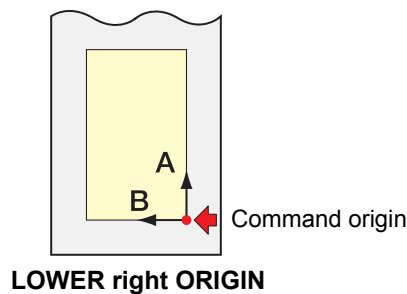

Rotation : ON

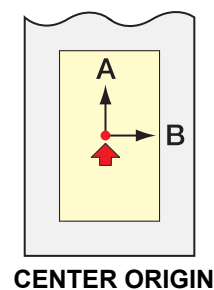
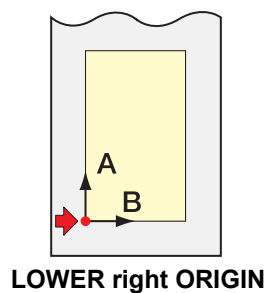

Important!

- Setting the command origin point to the [LOWERrightORIGIN] when using a roll sheet will expand the cutting area up to 51 m.
- The cutting area is 5 m if the command origin is set to [CENTER ORIGIN] when using a roll sheet .

Priority

Setting of priority is available with MGL-II c commands. Specifically, setting of priority is applied to the following commands.

Pen selection command	SP;
Pen lowering speed setting command	VS;
Pen lifting speed setting command	ZA;
Acceleration setting command	AS;
Pen pressure setting command	FS; ZF;
Cutter blade compensation setting command	ZO;

Size Reply Value

The setting value does not affect the actual available cutting area.

If the detected sheet size is smaller than the value of [DISTANCE], the detected size is sent to the computer as the reply value.

Sheet Sensor

The sheet sensor may not detect any transparent sheet or sheet whose back side is black. In such a case, the display shows the following error message.

Even in this case, cutting is enabled by setting the [SHEET SENSOR] function contained in the SET UP of FUNCTION to OFF.

- When the [SHEET SENSOR] function is set to OFF, set the cutting area; otherwise, the plotter may perform cutting for data outside the sheet or continue cutting even after there is no sheet left.

Jog Step

Accurate positioning can be achieved in any of the following cases:

- Two-point axis alignment (☞ P.3-3)
- Precise location of the origin

Dummy Cutting

The plotter executes dummy cutting in front of the pinch roller that is located on the side closer to the current location of the carriage. Set the dummy cut function to OFF if you do not want to dummy-cut the sheet that is to be used with characters cut out.

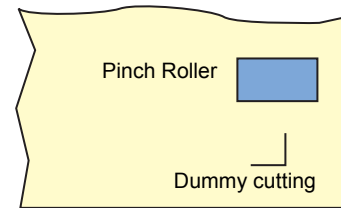

Important!

- The default setting of the dummy cut function is ON. If you set the dummy cut function to OFF, execute test cutting to adjust the cutter blade orientation prior to cutting. (☞ P.2-22)

Sheet Setting

Do not cut (plot) a heavy or wide sheet at a high speed; otherwise the sheet may deviate. Cutting (plotting) a heavy or wide sheet at a high speed may also result in the [ERR401 MOTOR B] error. In such a case, select [HEAVY] in the sheet setting.

Compensated Pressure Offset

Some part of the sheet remains uncut if the pressure to bring the cutter blade down into the sheet is too low. Some part around a corner of 120 degrees or less may remain uncut when an eccentric blade (available as an option) is used.

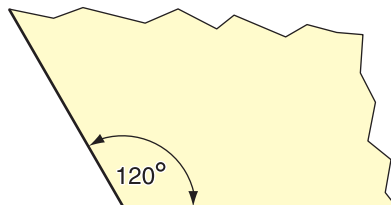

This problem can occur because of such an intended operation that the cutting pressure automatically drops (to approximately 5 g) around a corner to prevent the sheet from rising.

Some part may remain uncut if the cutting pressure is too low for the cutter blade to turn in the designed direction smoothly. In such a case, make setting to raise the cutting pressure for smooth cutting around corners.

If the pressure is too high and the joint positions of cut segments are outstanding, you can make it obscure by decreasing the pressure.

Copy the set value from the other user setting.

1 Press the **FUNCTION** key in the local mode.

<FUNCTION> SQUARE CUT <ENT>		
FUNC		

2 Press the jog key **▲** or **▼** to select [SET UP] .

<FUNCTION> SET UP <ENT>		
FUNC		

3 Press the **ENTER/HOLD** key.

4 Press the jog key **▲** or **▼** to select [CONFIG COPY].

<SET UP> CONFIG COPY <ent>		
FUNC		

5 Press the **ENTER/HOLD** key.

<SET UP> User No. : 1		
FUNC		

6 Press the jog key **▲** or **▼** to select the user setting number to copy.

<SET UP> User No. : 8		
FUNC		

7 Press the **ENTER/HOLD** key.

- Copy the setting item of the user selected in the Step 6 to the current user.

8 Press the **END** key two times for terminating this reset operation.

Important! • The setting values are kept in memory even when the power is turned off.

Reset the setting values to the initial state.

1 Press the **FUNCTION** key in the local mode.

<FUNCTION>	SQUARE CUT	<ENT>
FUNC		

2 Press the jog key **▲** or **▼** to select [SET UP] .

<FUNCTION>	SET UP	<ENT>
FUNC		

3 Press the **ENTER/HOLD** key.

4 Press the jog key **▲** or **▼** to select [SETUP RESET].

<SET UP>	SETUP RESET	<ent>
FUNC		

5 Press the **ENTER/HOLD** key.
• This is to initialize the setting items and parameters.

<SET UP>	INITIAL.OK?	[ENT]
FUNC		

6 Press the **END** key three times to stop and end initialization.

Important!

- The setting values are kept in memory even when the power is turned off.
- Initialize the current user setting. Other user settings are not initialized.

CHAPTER 4

In Case of Trouble



This chapter describes the actions to be taken when the plotter develops any trouble or displays an error message.

Before taking a phenomenon as a trouble	4-2
Troubles for which error messages are given on the LCD...	4-4
Error message	4-4
Status message	4-7

Before taking a phenomenon as a trouble

Take appropriate remedies according to the table below.
If still the problem cannot be solved, contact MIMAKI or its dealer.

Phenomenon	Cause	Remedy
Power does not turn on.	The power cable is not connected properly.	Connect the power cable to the plotter and to the wall outlet properly.
The plotter cannot perform cutting (plotting).	The plotter name setting on the host computer is wrong.	Check the plotter name setting on the host computer.
	The interface cable is not securely connected to the plotter and the host computer.	Securely connect the interface cable.
	USB driver has not been installed.	Install USB driver supplied with Fine Cut.
An error arises in the plotter when the host computer sends data to the plotter.	Command settings are wrong.	Correct the command settings between the application software and the plotter.
	Plotter model setting is wrong.	Correct the plotter model setting to [CG-SRIII series] on the application software.
The plotter cannot detect the sheet.	A transparent sheet or a sheet whose back side is black is used.	Set the sheet sensor function to OFF. (☞ P.3-77)
By cutting operation, the sheet is not cut, but perforated.	Screw for the tool holder is loose.	Tighten up the screw.
	The cutter blade protrudes excessively.	Adjust the protrusion of the blade properly.
	Half cut is set to "ON".	Make "OFF" of half cut of the tool condition.
	The blade is chipped or worn out.	Replace the blade with a new one.
	The blade does not rotate smoothly.	Replace the holder with a new one.
The actual cut length is different from the length specified on the data.	The sheet feeding length varies with the sheet thickness.	Correct the error margins by executing the distance compensation function. (☞ P.3-6)
Slippage of sheet arises in cutting.	The pinch rollers and grit rollers fail to securely retain the sheet in position.	Check the position of the pinch rollers and grit roller and adjust them so that they securely retain the sheet in position.
	The clamp pressure (high or low mode) has not been properly selected.	Select the proper clamp pressure. (☞ P.1-8)
	There is a slack in the roll sheet so that the sheet being fed meanders or skews.	Remove the slack in the roll sheet and straighten the right and left end faces of the roll when loading the roll sheet on the plotter. Then, start feeding the sheet.

Phenomenon	Cause	Remedy
Slippage of sheet arises in cutting.	The sheet was bent and came off the backing paper and thus there are air bubbles between them.	When a long leaf sheet is to be cut, take care not to bend the sheet while feeding or cutting it and do not put any extra load on the sheet. When a long leaf sheet is to be cut, provide a sufficient space for working in the direction of sheet feeding. Front: 1.5 m or more Rear: 1.5 m or more
	The setting direction (Front / Rear) of the sheet and the direction specified on the data do not agree with each other.	Correct the sheet setting or data setting.
	The sheet comes in contact with the floor surface. (The front end of the sheet is cut aslant.)	Decrease the cutting speed (SPEED) to reduce the load on the sheet when it comes in contact with the floor surface.
	The side margins of the sheet beside the pinch rollers are not enough.	Provide a side margin of 20 mm or more on each side of the sheet beside the pinch rollers.
The tool is dragged during operation. An unexpected imprint of the cutter remains on the sheet.	The sheet is warped.	Load the sheet on the plotter so that the sheet is not warped.
	The sheet is warped.	Turn the power off and try to lift/lower the tool holder by hand. If the tool holder does not move up but remains in the lower position, contact your distributor.
	An extremely thick sheet is used.	Use a sheet meeting the specification. Change the settings of UP HEIGHT (P.3-79)
Some parts remain uncut.	Low pressure on the cutter blade.	Increase the setting value of [ADJPRS OFS]. Raise the cutter pressure, and check the result -> Test plotting "SQUARE CUT"
		Check that [PRESS COMP.] is on.

Troubles for which error messages are given on the LCD

Error message

Error messages are shown as error numbers.

Take an appropriate remedy according to the table below. And if the remedy does not work, contact your distributor or an sales office of MIMAKI.

Error message	Cause	Remedy
ERROR C02 MAIN RAM	Trouble has occurred in the control RAM.	Contact your dealer or a sales office of MIMAKI.
ERROR C04 EEPROM	Trouble has occurred in the system ROM.	
ERROR C06 BUFFER	Trouble has occurred in the receiver buffer.	
ERROR C08 POWER	Trouble related to the motor has occurred.	
ERROR C10 COMMAND	Code other than command data has been received.	Check the command setting on the host computer.
ERROR C11 PARAMETER	A parameter outside the numerical range has been received.	Check the parameter.
ERROR C12 DEVICE	The plotter received an improper device control command.	Check the command setting on the host computer.
ERROR C13 PM OVER	Data on polygon has overflowed the polygon buffer.	Change the setting so that the polygon command is not used or the MGL-Ic1 command is to be used.
ERROR C15 AUTO FEED	The plotter has failed to feed the sheet by the length specified by the ZX command.	After completion of sending the data from the host computer, reload the long sheet and execute the plural sheets cutting.
	During division cutting, the plotter has failed to feed the sheet for cutting based on the second and subsequent data by the same length as for the first cutting.	Load a longer sheet on the plotter and set the remote mode again.
ERROR C16 AUTO I/F	The plotter has failed to detect a command automatically.	Set the command name. (☞ P.3-77)
ERROR C20 I/O	The communication condition is different.	Make the communication condition same as that of the host computer side. (☞ P.3-77)
ERROR C27 BUFFERover	The interface is faulty.	Check the interface cable.
ERROR 901 OPERATION	An invalid operation was performed on the control panel.	Refer to the relevant page of operation manual for valid operations.
ERROR C31 NO DATA	The plotter started the plural sheets cutting but found that there is no data in the receiver buffer.	Refer to the explanation of the plural sheets cutting function.(☞ P.3-9)
ERROR C32 DATAtooBIG	The amount of received data is too large for the plotter to perform the plural sheets cutting.	
ERROR C33 SHEET SIZE	The sheet is too short in the feeding direction.	Use a longer sheet.
ERROR 902 DAT REMAIN	The plotter executed an improper operation during a halt.	Press the REMOTE key to cut the remaining data or execute data clear if there is no need of using the data in the receiver buffer.(☞ P.3-48)
ERROR 41b ** NO MEDIA **	You performed the operation that becomes valid after sheet detection.	Perform sheet detection.

Error message	Cause	Remedy
ERROR C36 MARKdetect	No registration mark was detected.	Check the sheet for curling.
		Check to see if the starting point to detect the registration mark has been set properly. (☞ P.3-21)
		Check to see if the black registration mark is printed against the white background.
		Check to see if there is no dust or dirt between the registration marks.
		Check to see if there is no mistake in registration mark settings. (☞ P.3-16)
		Confirm the status and the settings described above. If still no registration mark is detected, contact your distributor or a sales office of MIMAKI.
		Set the "MARK FILL UP" of registration mark detection to "ON" when filled in around the registration mark. (☞ P.3-20)
ERROR C37 MARK ORG	The origin point was detected outside the cutting area.	Arrange the registration marks inside the sheet.
ERROR C38 MARK SCALE	Registration mark detection was not achieved. However, this error is attributable to a false detection or a compensation value setting error, since the calculated compensation value is wrong.	Correct the compensation value if it is wrong, and perform detection again.
	The required scale compensation value was not smaller than 1.3 times or not greater than 0.7 times.	Remove the cause of the detection error, for example, correct the blurred print of registration mark data and then retry.
	A detection error occurred since the distance from the adjacent graphics was too short.	Increase the distance from the adjacent graphics properly, and perform printing again.
	The designated spacing between the registration marks is not correct.	The value of the spacing between the registration marks designated by the command is wrong and it is attributable to a selection error of data. Therefore, check the output data.
	The print is not uniform and some graphics are omitted.	Correct the graphic data to obtain uniform print and perform printing again.
	As the printed registration mark was blurred, it was not read correctly and the registration mark of the next graphics was read by mistake.	Perform printing again with care that the print is not blurred.

Error message	Cause	Remedy
ERROR 401 MOTOR X	An excessive load was applied to the sheet feeding motor.	Turn the power off once and turn it on again.
ERROR 402 MOTOR Y	An excessive load was applied to the carriage driving motor.	Change the sheet setting to [HEAVY]. (☞ P.3-78)
ERROR 403 X CURRENT	An overcurrent error in the motor in the sheet feeding direction was detected.	When a roll sheet is used, perform sheet feeding to draw it out by a needed length beforehand.
ERROR 404 Y CURRENT	An overcurrent error in the motor in the sheet width direction was detected.	If the same error message still appears, contact your distributor or a sales office of MIMAKI.
ERROR 50a Y ORIGIN	The plotter has failed to detect the origin sensor.	Turn the power off once and turn it on again. If the same error message still appears, contact your distributor or a sales office of MIMAKI.
ERROR 50b FRONT EDGE	The plotter has failed to detect the front paper sensor.	
ERROR 50c WIDTH	The plotter has failed to detect the pinch roller sensor.	
ERROR 520 REAR EDGE	The plotter has failed to detect the rear paper sensor.	
ERROR C51 PINCH POS*	Pinch rollers are not properly set on the grit roller.	Set the pinch rollers on the grit roller.
ERROR C60 PenEncoder	The height of the pen cannot be detected.	Turn the power off once and turn it on again. If the same error message still appears, contact your distributor or a sales office of MIMAKI.
ERROR C61 Pen Stroke	The height of the pen is not proper.	Check whether the pen line rubber is not extremely worn or there is neither lifting nor change of shape. Check whether a foreign material adheres on the pen line rubber. When attaching a pen in a pen holder in the marketplace, check whether it is attached in the proper position. Even if there is no abnormality in the above mentioned items and an error is still displayed, contact our sales office.

Status message

The messages given below appear in the remote mode.
They do not indicate errors but require an appropriate action.

Message	Cause	Remedy
** OFFSCALE **	The cutting data exceeds the effective cutting area. Or the plotter has stopped after cutting the sheet up to its end normally.	Use a larger sheet, decrease the amount of data or execute the divided cutting function.
** NO SHEET **	No sheet has been set or a transparent sheet has been set.	Load a sheet or turn off the sheet sensor.
** VIEW **	The plotter has received the not-ready-mode (NR;) signal from the host computer and has entered the local mode.	Execute the required operations, such as the sheet detection or the establishment of an origin. Then, press the (REMOTE) key to make the plotter to enter the remote mode.
** DIGITIZE **	The plotter has received the digitization command (DP;) from the host computer and has entered the digitization mode.	Move the pen to a desired location, where necessary, and press the (REMOTE) key. To reset the digitization mode, execute the data clear using the (FUNCTION) key.
** END COPY **	The plotter has terminated copying after completion of one sheet copying, since the data received contains the origin updating command (ZT;, !PG;).	The plural sheets cutting function is disabled. To perform plural sheets cutting, change the setting back to enable the function on the host computer.
* DIVISION * 5s	The plotter has finished the cutting corresponding to a division of the data that exceeds the sheet width, using the division cut function, and is now waiting for the receipt of the next data.	If the plotter does not receive any data from the host computer within ten seconds, it will recognize the data has ended. Then, the plotter will perform the frame cutting and mark cutting and enter the local mode.
* END DIVISION *	This message appears in any of the following cases: The plotter has received data that contains the origin updating command (ZT;, !PG;). The sheet width is 1 cm or less. The sample cutting data exceeds the sheet width. The two-point axis alignment is set to ON. Registration marks have already detected.	Division cut is disabled.

Message	Cause	Remedy
COPY SKIP	A mark cannot be detected during continuous copying. One pattern is skipped.	There is no problem if the marks are successfully detected after skipping one pattern. If marks cannot be detected continuously by five patterns or more, [ERR36 MARKdetect] (☞ P.4-5) is displayed.
MEDIA SKEW <ENT>	The deviation of the sheet exceeded the setting value of the SKEW CHECK (☞ P.3-20)	Press the (ENTER/HOLD) key after resetting the sheet.
PAUSE REMOTE/ END	The plotter is holding the mark detect operation, since (REMOTE) has pressed while detecting a mark.	Press (REMOTE) key to resume the mark detection, or press (END) to end the operation.
SHEET EXCHANGE	The plotter is waiting for the sheet to be replaced during continuous copying in the leaf sheet mode.	Replace the leaf sheet (cut sheet) with a new one, and resume continuous copying.
	During Y direction division cut, the cutting exceeds the sheet length.	Please set media with more sheet length.
F-ROM WRITING	The plotter is now storing the tool parameters and setting parameters. The data is saved in flash memory so that the saved data will not be erased even when the power is turned off.	Do not turn the power off while this message is displayed.
SHEET END REM/END	End of the sheet is detected while detecting a mark or cutting roll sheet.	Cutting cannot be continued, since roll sheet has ended. Press the (END) key and replace it with new sheet.
	Sheet is lifted.	Fix the lifting of the sheet and press the (REMOTE) key to resume cutting.
	The back of the plotter is exposed to intense light.	Turn the plotter around not to be exposed to the light, and press the (REMOTE) key to resume cutting.

CHAPTER 5

Appendix



The appendix describes the replacement procedure for the cutter blade and the specifications of the plotter.

- Specifications of the main unit..... 5-2**
 - Repeatability condition5-3
- Cutter blade 5-4**
 - Replacing the cutter5-4
 - Adjusting the cutter blade5-4
 - Replacing the cutter other than supplied one5-5
 - Adjusting blade edge of cutter other than supplied one5-5
- Note slip..... 5-6**
- Function Flowchart..... 5-7**
 - Functions invoked with the specific keys5-7
 - Functions invoked with the jog mode (jog keys)5-9
 - Functions5-10

Specifications of the main unit

Item		CG-60SRIII		CG-100SRIII		CG-130SRIII	
Acceptable sheet width		mm	inch	mm	inch	mm	inch
		90~740	4~28	90~1250	4~48	90~1550	4~60
Acceptable roll sheet	Outside diameter	150mm or less		200mm or less, Sheet			
	Sheet weight	8 kg or less		20 kg or less			
Effective cutting area*1		606 mm X 51 m		1070 mm X 51 m		1370 X 51m	
Maximum speed	Shaft direction	70 cm/s					
	45° direction	100 cm/s					
Speed setting (cutting/plotting)		1 ~ 10cm/s (in 1 cm/s steps) 10 ~ 70cm/s (in 5 cm/s steps)					
Mechanical resolution		X: 2.5µm, Y: 5µm					
Program steps		25, 10µm (MGL-IIc) 100, 50,µm(MGL-Ic1)					
Repeatability*2		0.2 mm / 2m (excluding expansion/contraction due to film temperatures)					
Guaranteed range of accuracy (repeatability)		606 mm X 2 m		1070 mm X 2 m		1370 X 2m	
		(depending on the specified film and cutting conditions)					
Maximum pressure		500 g					
Pressure setting	Cutter	10 ~ 20g(2 g step)					
		20 ~ 100g(5 g step)					
		100 ~ 500g(10 g step)					
	Pen	10 ~ 20g(2 g step)					
20 ~ 100g(5 g step)							
100 ~ 150g(10 g step)							
Acceptable films		PVC sheets (0.25 mm thick or less, included laminated sheet), fluorescent sheets*3, reflective sheets*4, rubber sheet					
Applicable tools		Eccentric cutters, water-based ball-point pens, oil-based ball-point pens, commercially available ball-point pens*4					
Commands*5		MGL-IIc, MGL-Ic1					
Interface		USB, RS-232C, Ethernet					
Receiver buffer		Approximately 27 MB standard (Approximately17MB when the sorting function is effective.)					
Operating environment		5 to 35°C, 35 to 75 % (Rh) Non-condensing					
Power capacity		AC100 to AC240 V 140 VA to 168VA		AC100 to AC240 V 190 VA to 228VA			
Outside dimensions	(W)	1030 mm		1530 mm		1830 mm	
	(D)	287 mm		580 mm			
	(H)	335 mm		1150 mm			
Weight		24 kg		41 kg		46 kg	
Noise*6		During standby (plotting)50 dB (Absorption fan at low speed) During cutting (plotting)70 dB (Continuous sounds)					

*1. The maximum feed length is limited by the software.

The maximum feed length is limited also by the sheet setting condition or by the effect of obstacles encountered on the sheet path. As a rule of thumb, limit the maximum feed length for one of the data to 2 m.

*2. To achieve the guaranteed range of accuracy, the next page's requirements must be satisfied.

*3. The blade (SPB-0007) dedicated for fluorescent sheets or the blade (SPB-0006) dedicated for reflective sheets must be used.

*4. Use the tools supplied as standard accessories.

If any other ball-point pen available on the market is to be used, select the one whose diameter is 8 to 9 mm and which is free from bumps or taper in the area to be clamped. The image quality is not guaranteed because the pen tip position differs depending on the pen in use.

*5. With the USB connection, the ESC type commands among the MGL-IIc commands cannot be used.

*6. The values are based on MIMAKI's measurement conditions.

Repeatability condition

Plotter conditions

- When using a exclusive roll-placing table.
- The clamp pressure must be set to “HIGH” .



- The specified repeatability may not be guaranteed depending on the material of the sheet to be cut or ink jet media,

Sheet setting conditions

- Side margin of the sheet: 20 mm or more
- Front side condition of the sheet: No warp or rising
- No separation of the sheet from the base paper (no air bubbles between them), which can be caused by bending of the sheet
- The sheet must be loaded properly using the sheet feed function.
- The roll sheet must be free from loose rolling . (The right and left end faces must be flat.)

Cutting speed

- 40 cm/s or less (when the cutter supplied with the plotter is used)

Cutting data

- Test pattern for maintenance (continuous 5 strokes in the lengthwise direction)
- During cutting, there must be no separation of the sheet from the base paper (no air bubbles between them), which can be caused by excessive bending of the sheet.

Cutter blade



- The cutter blade is sharp. Keep your fingers away from the cutter.
- Do not shake or swing the cutter holder; otherwise, the cutter blade may come off, which is dangerous.
- Keep the cutter out of reach of children. Dispose of the used cutter blade in compliance with the applicable regulations.

Replacing the cutter

If the cutter is chipped or blunt, replace it with a new one. (Accessory parts number: SPA-0030)
New cutter (low-pressure blade set for PVC sheets: Model SPB-0030) are available from your distributor or MIMAKI's sales office.

Name of product	Product No.	Specifications	Remarks
Decentering blade for vinyl sheet	SPB-0001	Package of three pieces of blades	
Decentering blade for small letters	SPB-0003	Package of three pieces of blades	
Decentering blade for rubber sheet	SPB-0005	Package of three pieces of blades	
Decentering blade for reflecting sheet	SPB-0006	Package of two pieces of blades	
Decentering blade for fluorescent sheet	SPB-0007	Package of three pieces of blades	
Replacing the cutter other than supplied one	SPB-0030	Package of three pieces of blades	supplied one
Decentering blade for thick rubber sheet	SPB-0084	Package of three pieces of blades	

1

Remove the cap located at the edge by rotating it.

2

Replace the cutter with a new one using tweezers or the like.

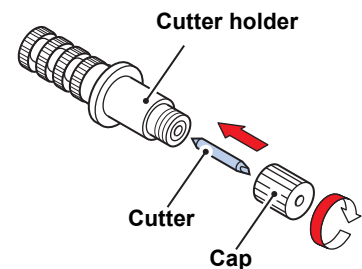

Adjusting the cutter blade

After adjusting the blade edge, set the cut condition and perform test cut to check whether cutting is performed well.

1

Turn the adjusting knob to adjust the protruding amount of the cutter.

- arrow to protrude the cutter blade.
(0.5 mm per revolution)

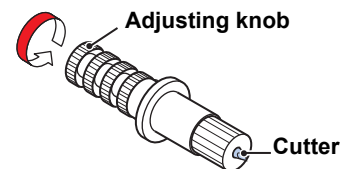

Replacing the cutter other than supplied one

- 1 Loosen the lock nut, and pull the adjusting knob out of the holder.

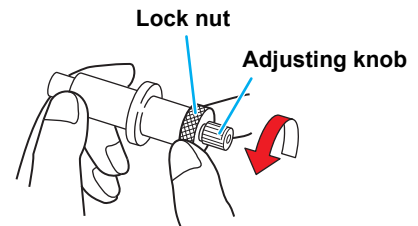

- 2 Insert the cutter into the adjusting knob using tweezers.

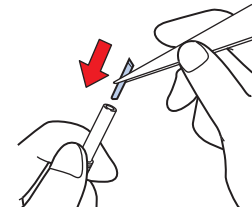

- 3 Tighten the lock nut.

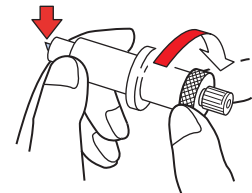

Adjusting blade edge of cutter other than supplied one

After the completion of adjustment, be sure to set cutting conditions and perform test cutting to check the cutting quality.

- 1 Remove the cutter holder, and loosen the lock nut.

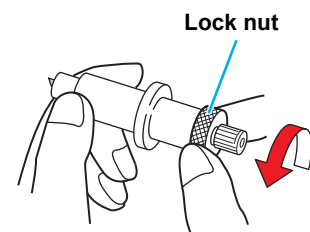

- 2 Turn the adjusting knob to adjust the protruding amount of the cutter blade.

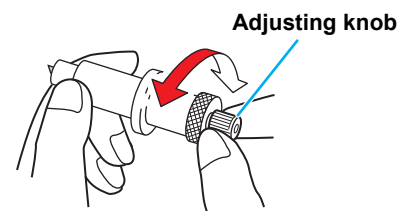

- 3 Tighten the lock nut so that the adjusting knob will not turn.



- The blade adjuster (adjuster: OPT-S1005) will facilitate the adjustment of the protruding amount of the blade.

Note slip

When changing the sheet for cutting (plotting), distance correction may be required depending on the sheet thickness. (☞ P.3-6)

In that case, the following note slip is useful to note down the sheet name and the distance correction value.

Sheet Name: A=B=	Sheet Name: A=B=
Sheet Name: A=B=	Sheet Name: A=B=
Sheet Name: A=B=	Sheet Name: A=B=
Sheet Name: A=B=	Sheet Name: A=B=
Sheet Name: A=B=	Sheet Name: A=B=
Sheet Name: A=B=	Sheet Name: A=B=
Sheet Name: A=B=	Sheet Name: A=B=

Function Flowchart

Functions invoked with the specific keys

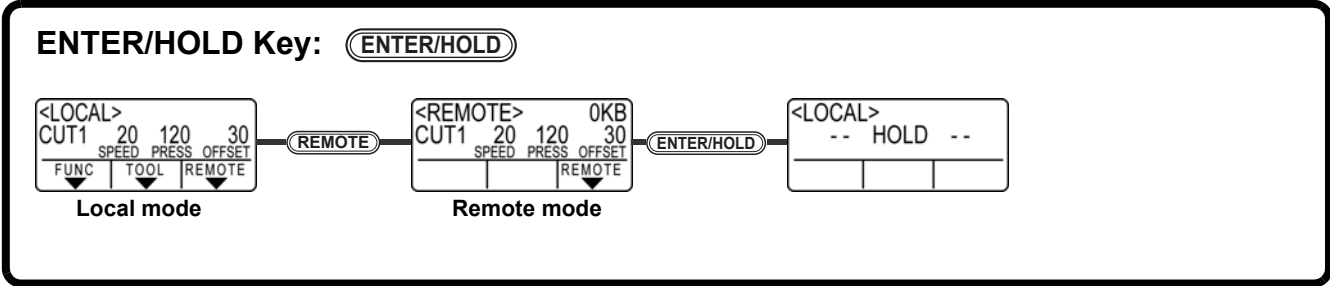
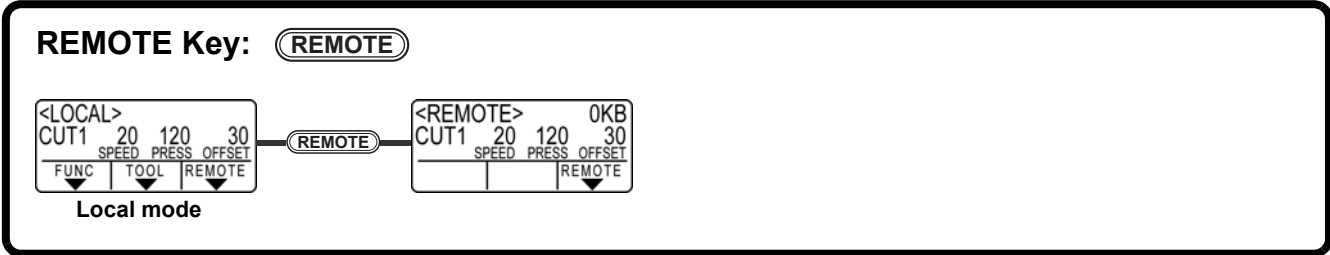

TOOL Key (Settings of Tool conditions): **TOOL**

<REMOTE>	OKB
CUT1	20 120 30
	SPEED PRESS OFFSET
	REMOTE

REMOTE

<LOCAL>	
CUT1	20 120 30
	SPEED PRESS OFFSET
	FUNC TOOL REMOTE

Local mode

TOOL

<CUT CONDITION>	
CUT1	20 120 30
	SPEED PRESS OFFSET
	FUNC TOOL REMOTE

▲ ▼ **ENTER/HOLD**

TOOL

<CUT CONDITION>	
CUT2	20 50 30
	SPEED PRESS OFFSET
	TOOL

▲ ▼ **ENTER/HOLD**

TOOL

<CUT CONDITION>	
CUT3	20 120 30
	SPEED PRESS OFFSET
	FUNC TOOL REMOTE

▲ ▼ **ENTER/HOLD**

TOOL

<CUT CONDITION>	
PEN	20 120
	SPEED PRESS OFFSET
	TOOL

▲ ▼ **ENTER/HOLD**

TOOL

<CUT CONDITION>	
CUT4	20 120 30
	SPEED PRESS OFFSET
	FUNC TOOL REMOTE

▲ ▼ **ENTER/HOLD**

TOOL

<CUT CONDITION>	
CUT5	20 120 30
	SPEED PRESS OFFSET
	FUNC TOOL REMOTE

▲ ▼ **ENTER/HOLD**

TOOL

<CUT CONDITION>	
CUT6	20 120 30
	SPEED PRESS OFFSET
	TOOL

▲ ▼ **ENTER/HOLD**

TOOL

<CUT CONDITION>	
CUT7	20 120 30
	SPEED PRESS OFFSET
	TOOL

▲ ▼ **ENTER/HOLD**

Functions invoked with the jog mode (jog keys)

Setting an origin

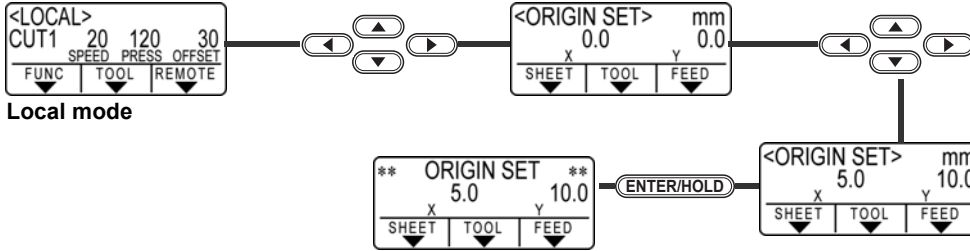

Cutting area

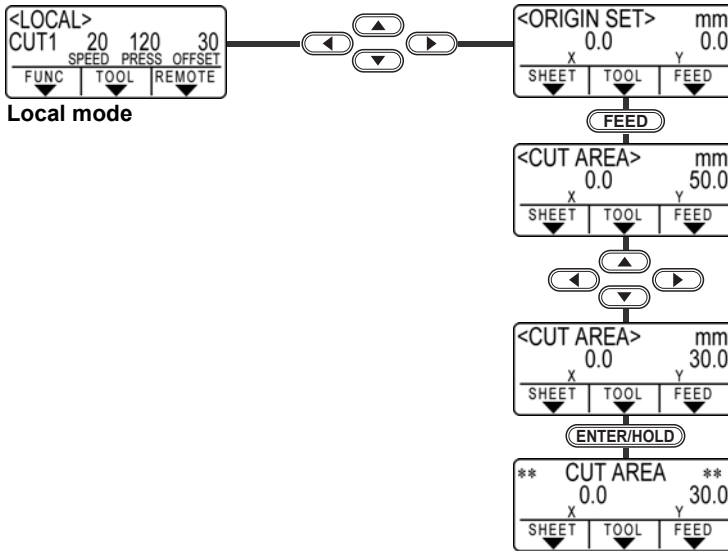

Two-point axis alignment

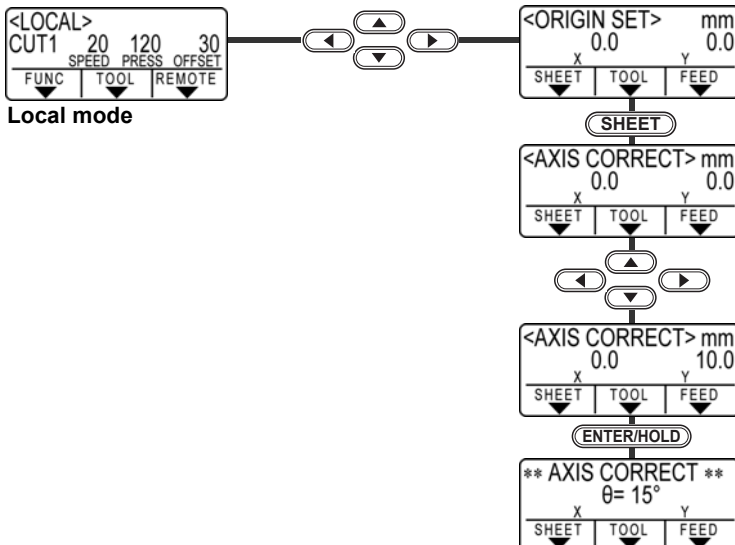

Functions

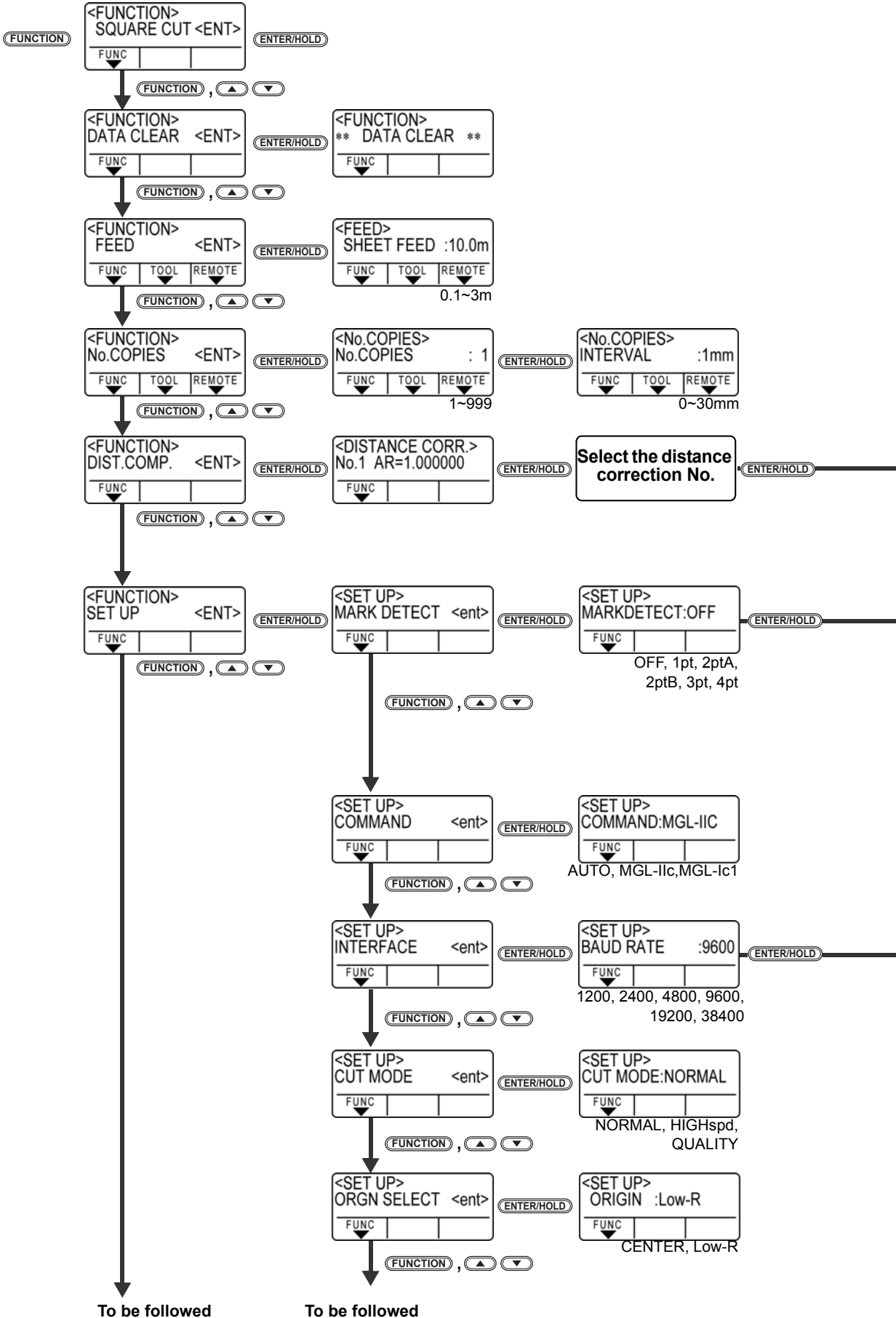
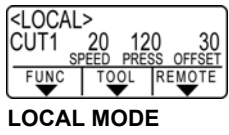

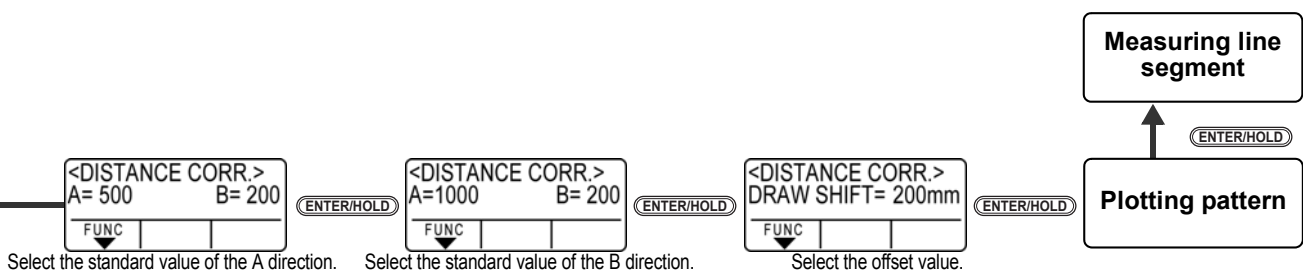

Settable when [MARK DETECT] is not OFF

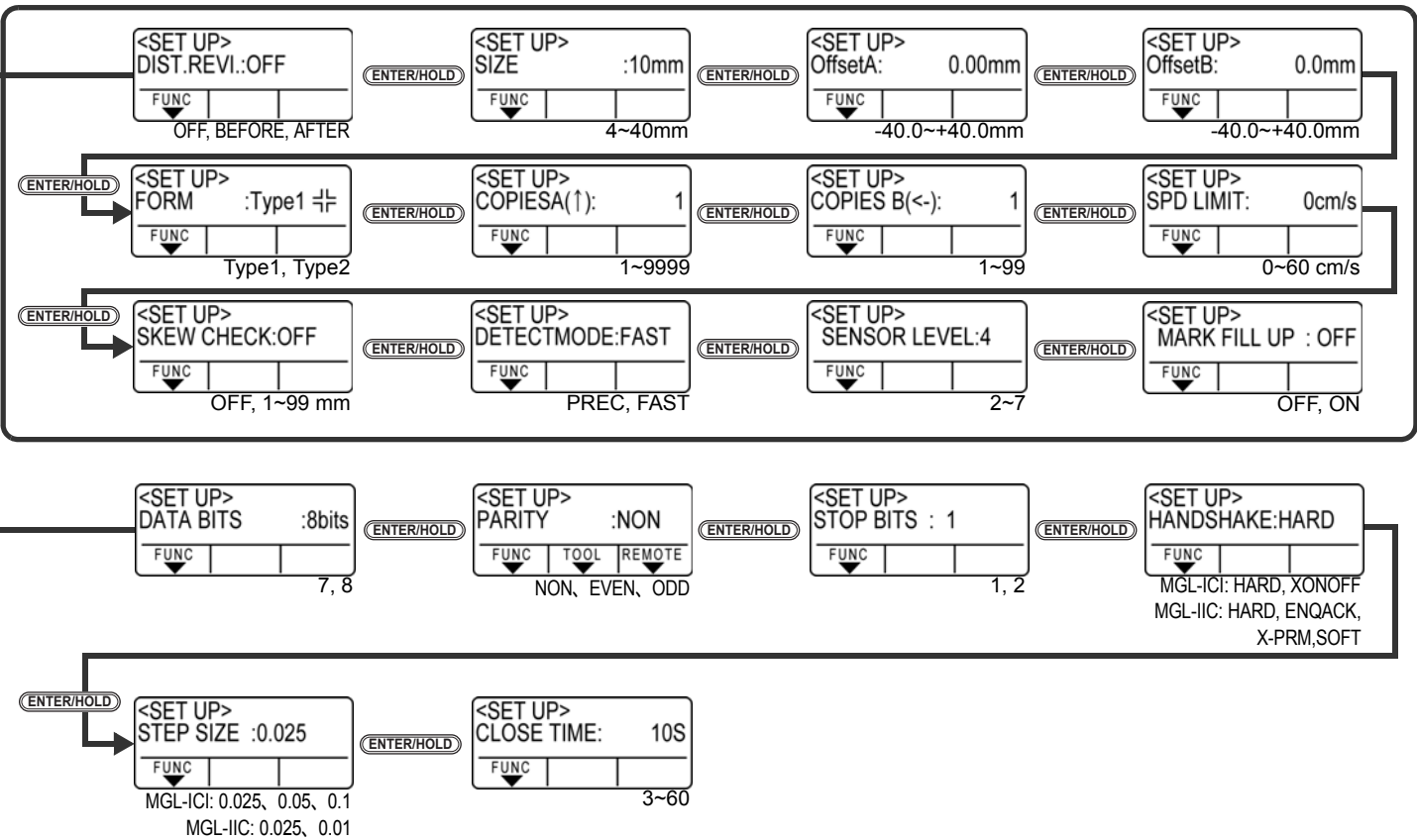

From P.5-10

From P.5-10

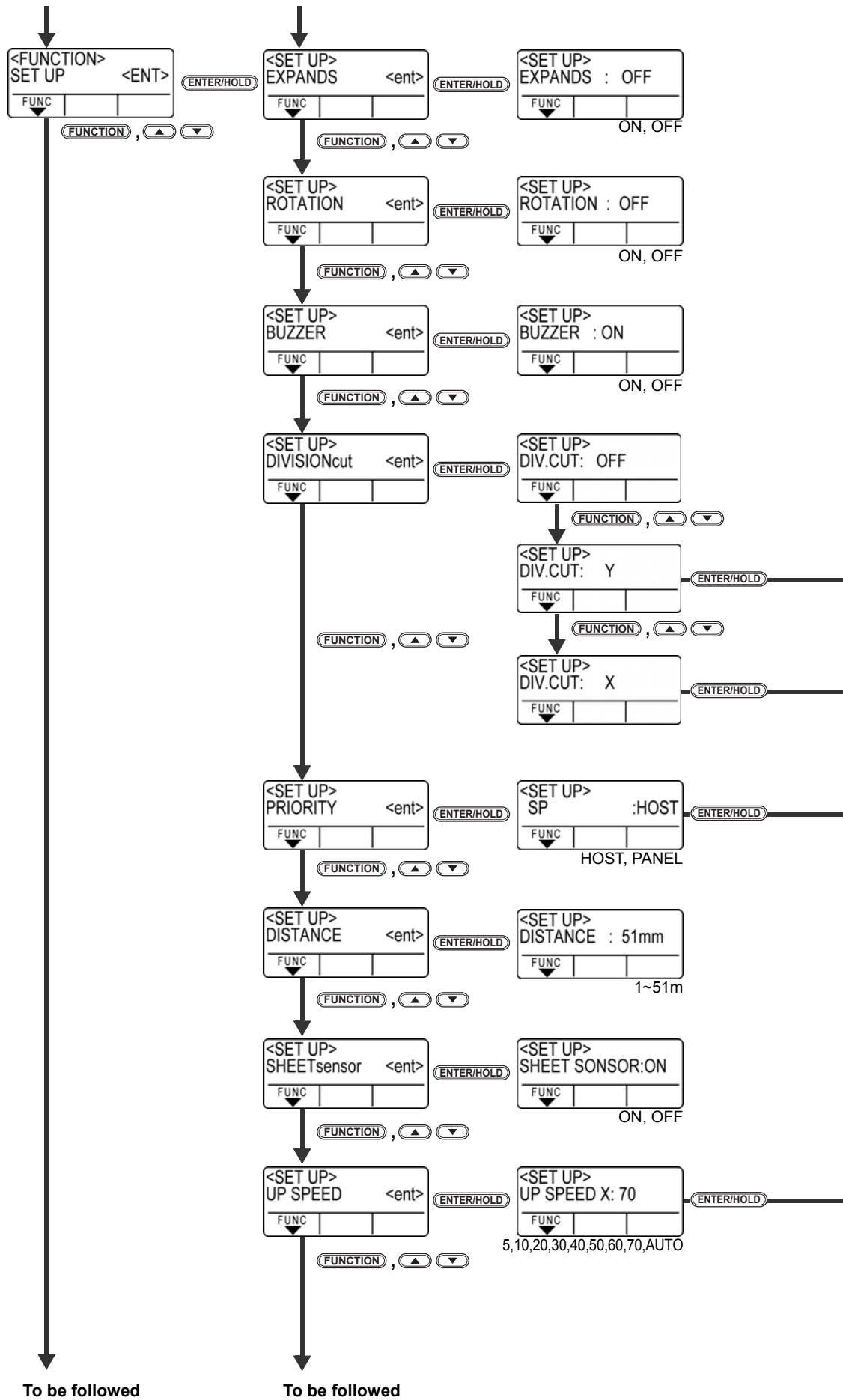

Settable when [DIVISION cut] is ON

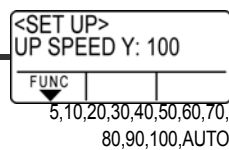
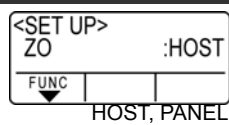
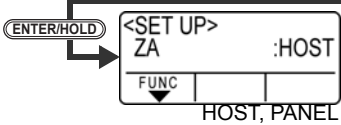
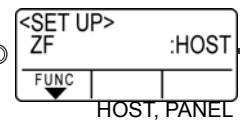
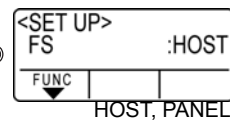
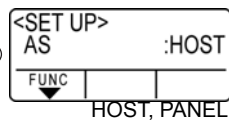
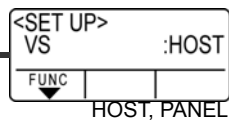
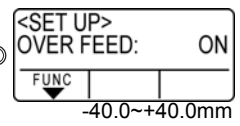
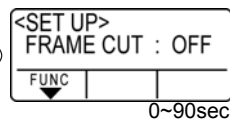
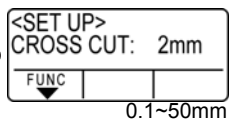
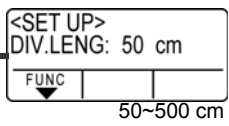
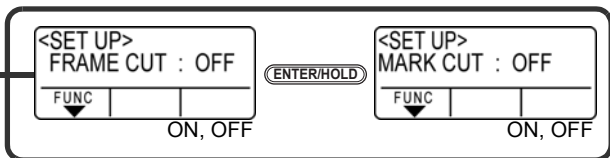

From P.5-12

From P.5-12

To be followed

To be followed

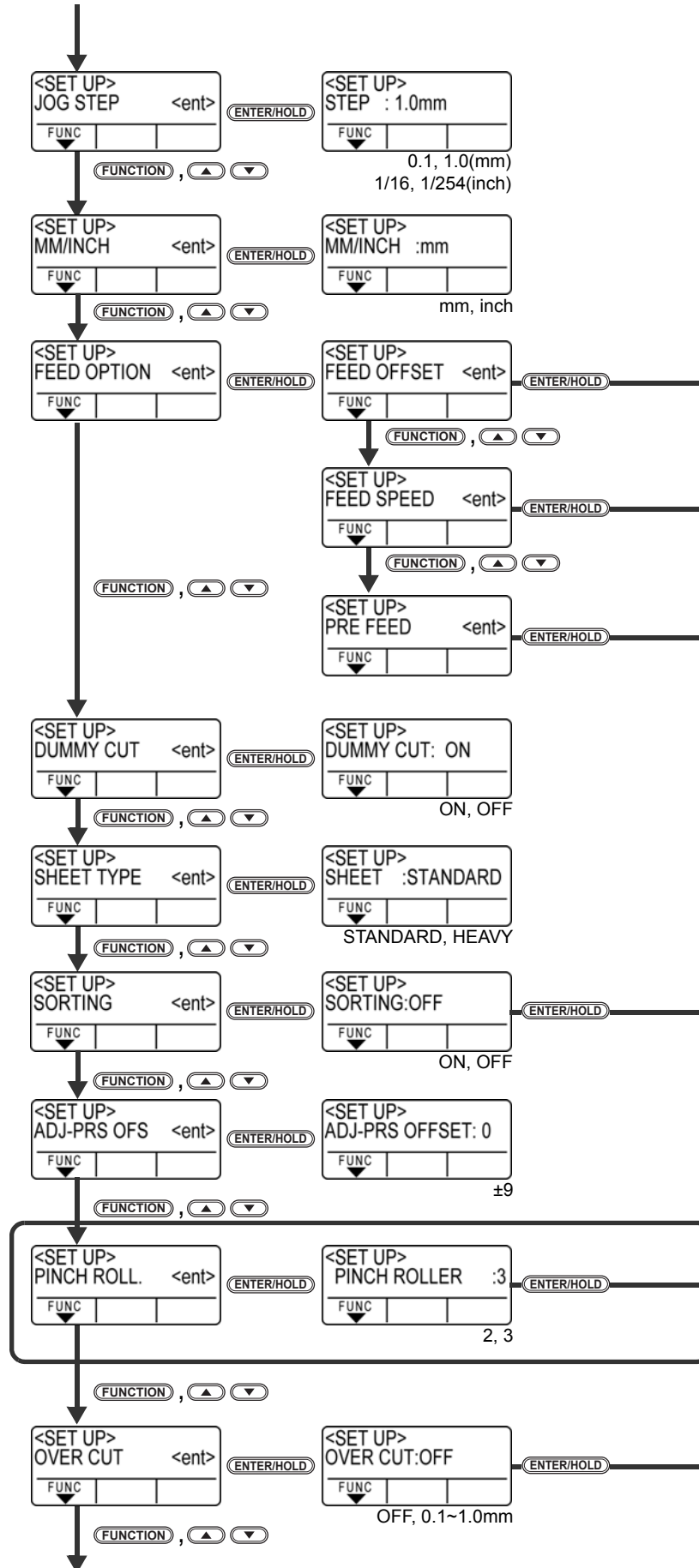

<SET UP>
FEEDOffset: 0cm
FUNC
1~20 (cm/s)

<SET UP>
FEED SPEED: 0
FUNC
1~20 (cm/s)

<SET UP>
FEED COUNT: OFF
FUNC
OFF, 1~5 (times)

ENTER/HOLD

<SET UP>
FEED LENG: 3.0m
FUNC
0.1~5m

ENTER/HOLD

<SET UP>
TIME WAIT: 0sec
FUNC
0~90sec

ENTER/HOLD

<SET UP>
OVER FEED: ON
FUNC
-40.0~+40.0mm

Settable when [SORTING] is ON

<SET UP> AUTO FEED:OFF FUNC ON, OFF	ENTER/HOLD	<SET UP> AREA:OFF FUNC OFF, 10~5100 cm
--	------------	---

Settable for the machine type with more than three pinch rollers

<SET UP>
ROLL.SELECT:ON
FUNC
ON, OFF

<SET UP>
CORNER CUT :OFF
FUNC
ON, OFF

From P.5-14



To be followed

From P.5-14

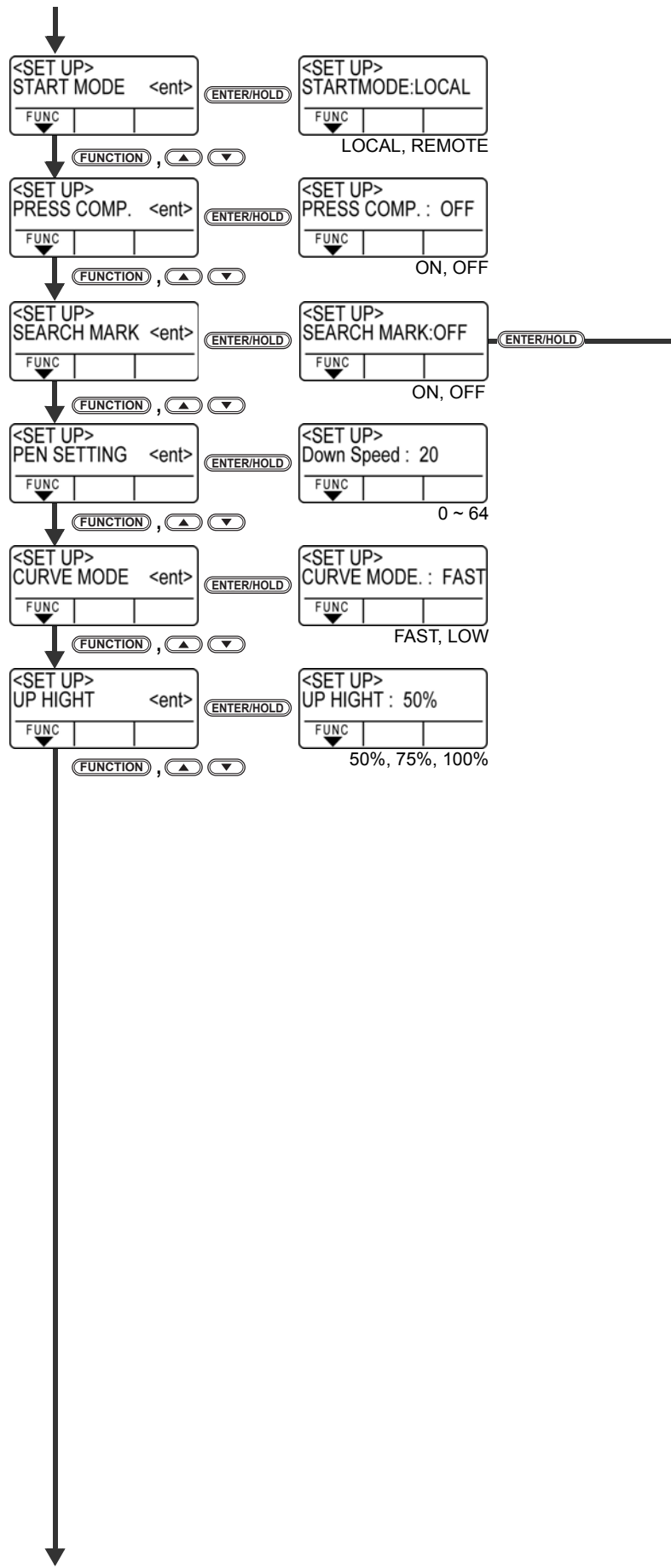

To be followed

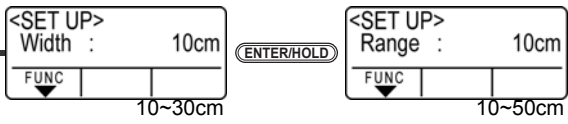

From P.5-16

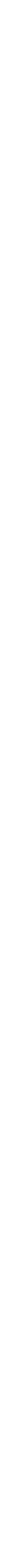

To be followed

From P.5-16

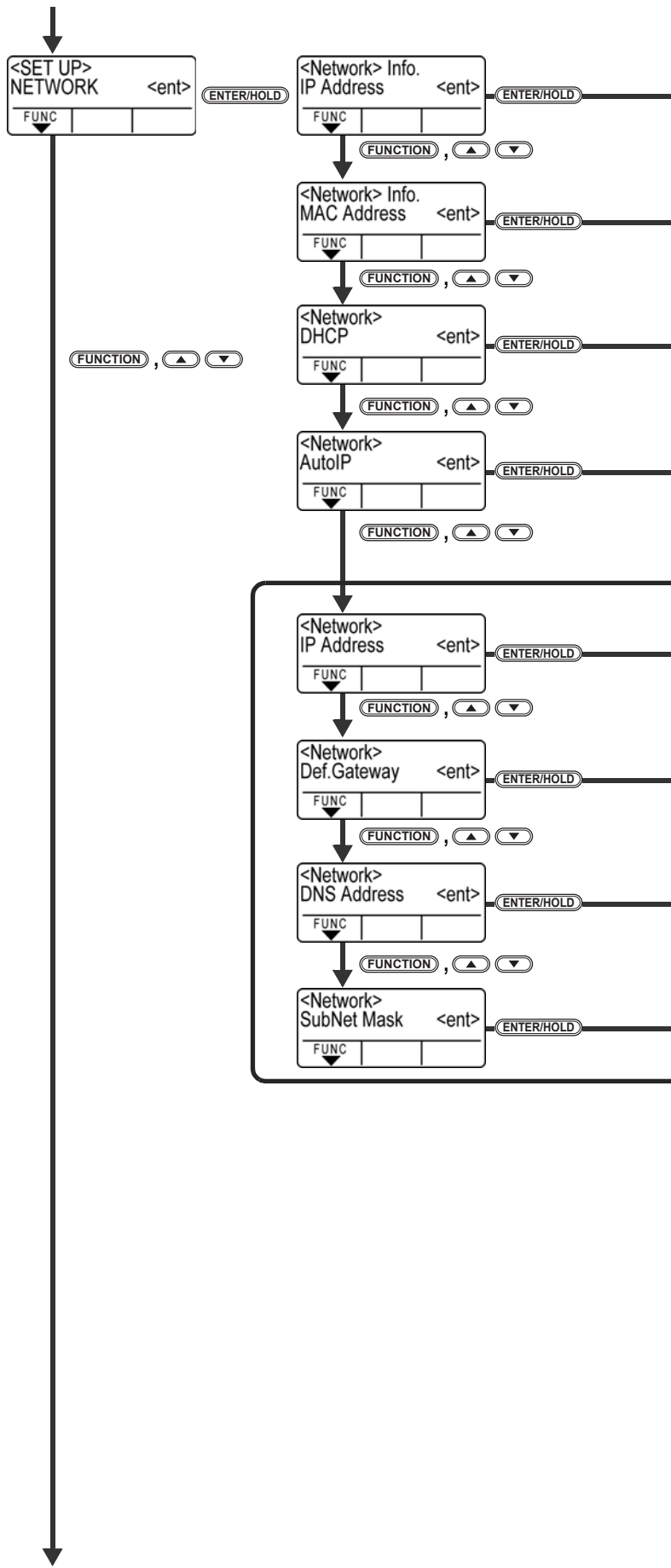

To be followed

IP Addr. Info. 10. 16. 168.235
FUNC

MAC Addr. Info. 00 : d0 : 1b >
FUNC



MAC Addr. Info. < 00 : 00 : 05
FUNC

DHCP :ON
FUNC

ON, OFF

AutoIP :ON
FUNC

ON, OFF

Settable when [DHCP] and [AutoIP] are both OFF

IP Address 0. 0. 0. 0.
FUNC

Default Gateway 0. 0. 0. 0.
FUNC

DNS Address 0. 0. 0. 0.
FUNC

Sub Net Mask :24
FUNC

From P.5-18

FUNCTION , ▲ ▼



To be followed

From P.5-18

FUNCTION , ▲ ▼



To be followed

<EVENT MAIL> Delivery <ent>	
FUNC	

ENTER/HOLD

FUNCTION , ▲ ▼

<EVENT MAIL> Event <ent>	
FUNC	

ENTER/HOLD

FUNCTION , ▲ ▼

<EVENT MAIL> Mail Addr. <ent>	
FUNC	

ENTER/HOLD

FUNCTION , ▲ ▼

<EVENT MAIL> Subject <ent>	
FUNC	

ENTER/HOLD

FUNCTION , ▲ ▼

<EVENT MAIL> Server <ent>	
FUNC	

ENTER/HOLD

FUNCTION , ▲ ▼

To be followed

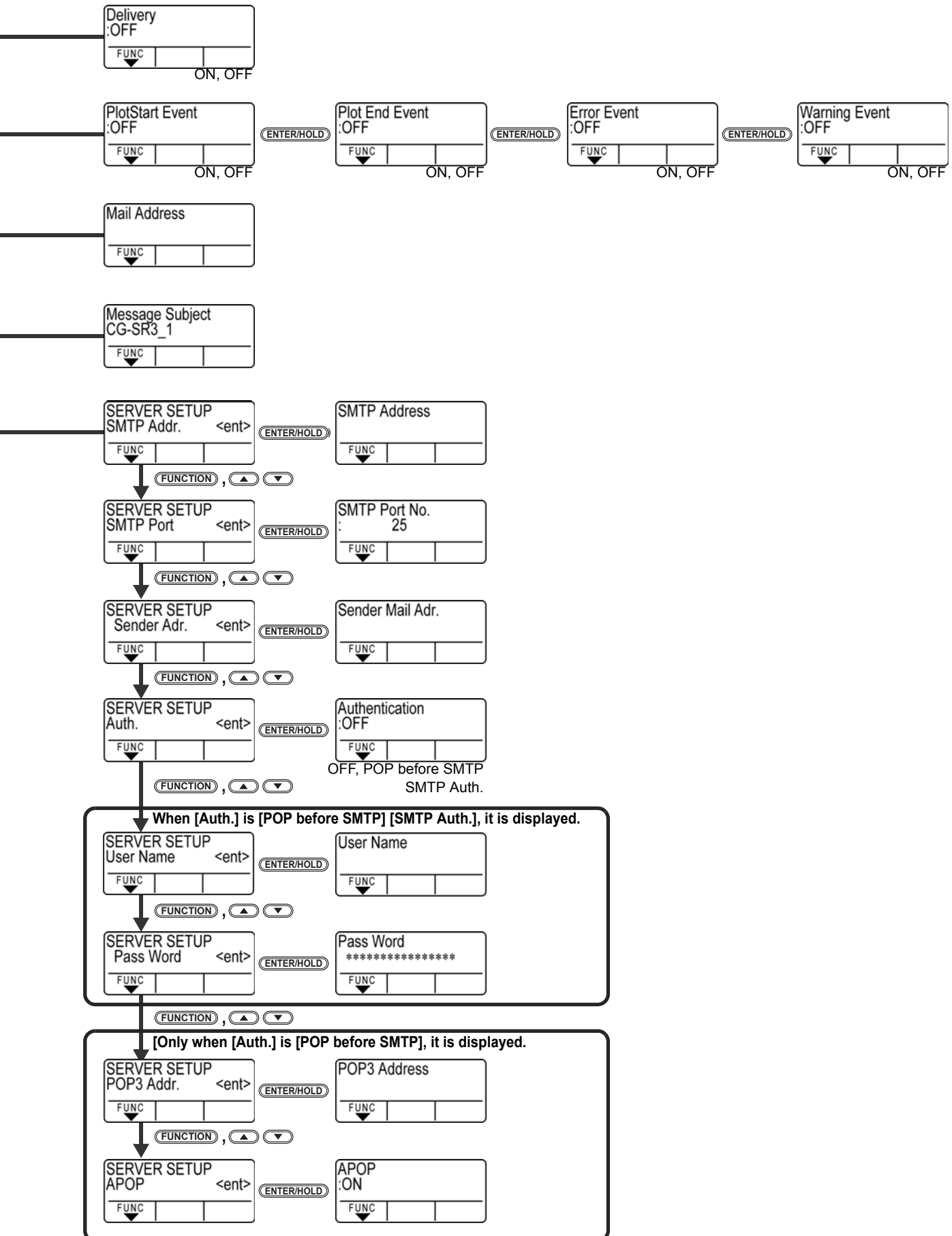

From P.5-20

From P.5-20

From P.5-20

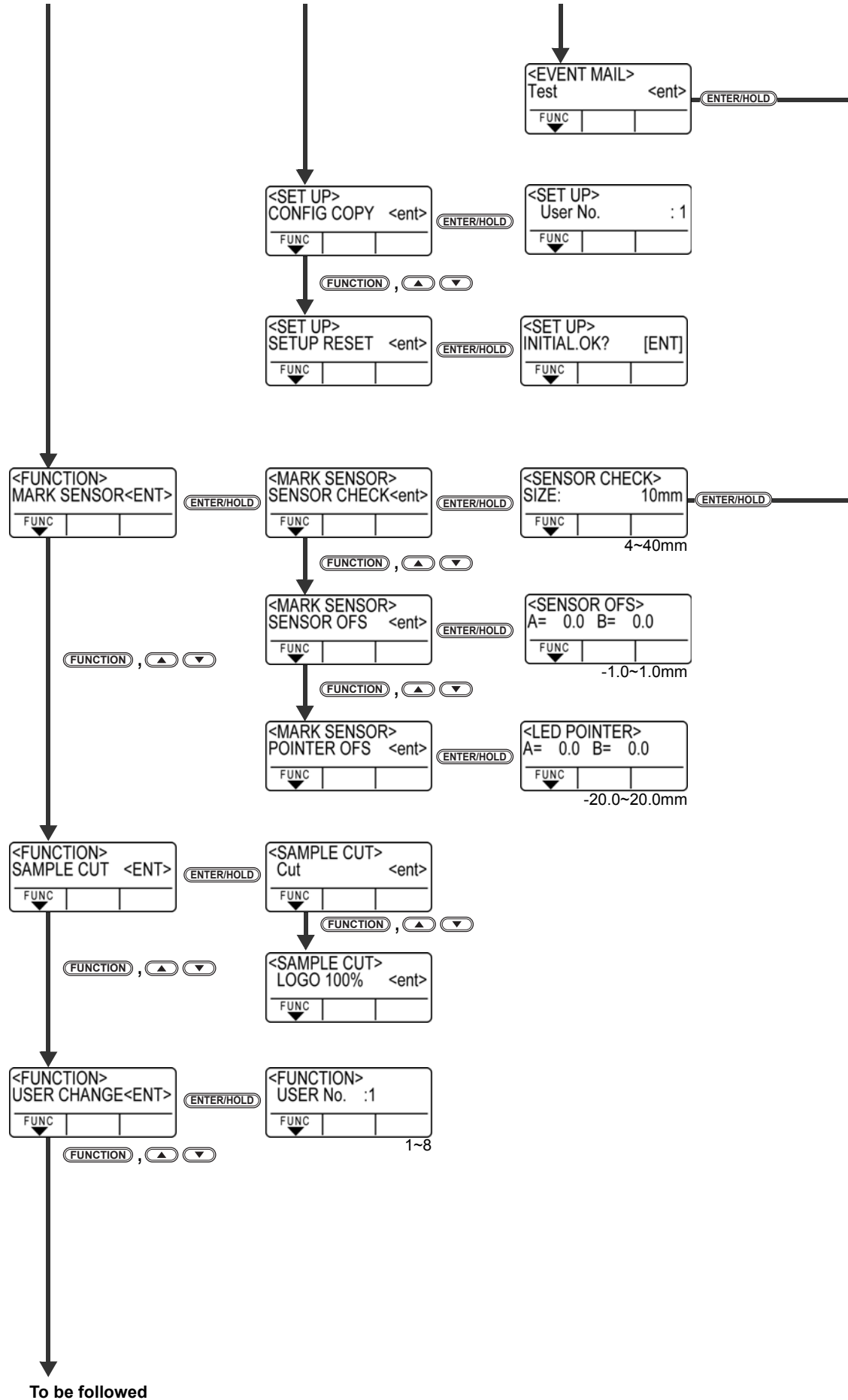

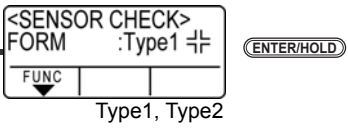

From P.5-22

